

**SPRINTUS**

Professional Cleaning Equipment

# CATALOGUE 2025



AVOIDANCE  
REDUCTION  
COMPENSATION

## IN FAVOUR OF HOLISTIC CLIMATE PROTECTION

We manufacture our top products at our company headquarters in southern Germany and we attach great importance to developing sustainable and resource-saving products.

We are continuously reducing the proportion of new plastics in our products while maintaining their quality and functionality.

We offset unavoidable CO<sub>2</sub> emissions through a financial climate contribution and offer products with a financial climate contribution on request.



Your partner for professional cleaning.

SILVER | Top 15%

ecovadis

Sustainability Rating

FEB 2024

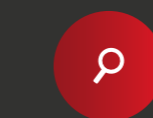

[www.sprintus.eu](http://www.sprintus.eu)

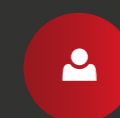

[kontakt@sprintus.eu](mailto:kontakt@sprintus.eu)



Phone: +49 7182 / 80 404-0  
Fax: +49 7182 / 80 404-99



Reizenwiesen 1  
73642 Welzheim /Germany

Environment

Labor and human rights

Sustainable Procurement

Ethics

SILVER | Top 15%

ecovadis

Sustainability Rating

FEB 2024

## ECOVADIS SILVER MEDAL FOR SPRINTUS

We were recognized for our sustainability successes in February 2024 with the EcoVadis silver medal. This result puts SPRINTUS in the top 15 percent of all companies assessed by EcoVadis in the previous 12 months.

## LEARN MORE ABOUT ECOVADIS

EcoVadis provides globally recognized and trusted sustainability ratings for companies. More than 130,000 companies in over 180 countries and more than 220 industries are rated by EcoVadis. The focus is on the environment, labor and human rights, ethics and sustainable procurement.

You can find more information at [www.ecovadis.com](http://www.ecovadis.com)



We present to you our

## Product catalog 2025

Our top priority is to offer our customers reliable, efficient and sustainable cleaning solutions.

This is also epitomised by our ZERO dry vacuum cleaners with their new features! They set new standards with regard to our environment and at the same time offer outstanding quality and functionality. The ZERO dry vacuum cleaners are manufactured at our company headquarters in southern Germany and consist of up to 75% recycled plastic. They are part of our ZERO products, for which we have determined unavoidable CO<sub>2</sub> emissions in accordance with the Greenhouse Gas Protocol and offset them by supporting internationally recognised climate protection projects.



We strive every day to use our resources responsibly and sustainably. As a German company, we are very proud to manufacture our top products at our headquarters in Germany. By moving into our new assembly and logistics center, we can expand our production and logistics area to a total of 10,000 m<sup>2</sup>. This will guarantee us the spatial growth opportunities for the coming years at our headquarters. As a company with a financial climate contribution, we want to reduce our ecological footprint not only by avoiding and reducing emissions, but also by offsetting them.

SPRINTUS was awarded the EcoVadis silver medal in February 2024. This reflects our successful sustainability management in the areas of the environment, labor and human rights, ethics and sustainable procurement.

We are delighted to receive this award and wish you lots of fun browsing through the catalogue, testing our products and cleaning.

Your SPRINTUS Team





# SPRINTUS GLOBAL



Our top sellers are **MADE IN GERMANY**. In this way we take responsibility for our environment, employees and society. We can also offer our products with a financial climate contribution on request.



SPRINTUS is an international, family-owned company with deep roots in South Germany.

Innovative and customer-orientated, we are always there for you with our specialist consultants nationally and internationally.

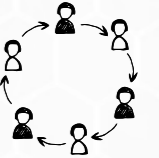

We are represented both in Germany and at the international cleaning industry trade fairs and beyond. Here we regularly present our innovative new products.

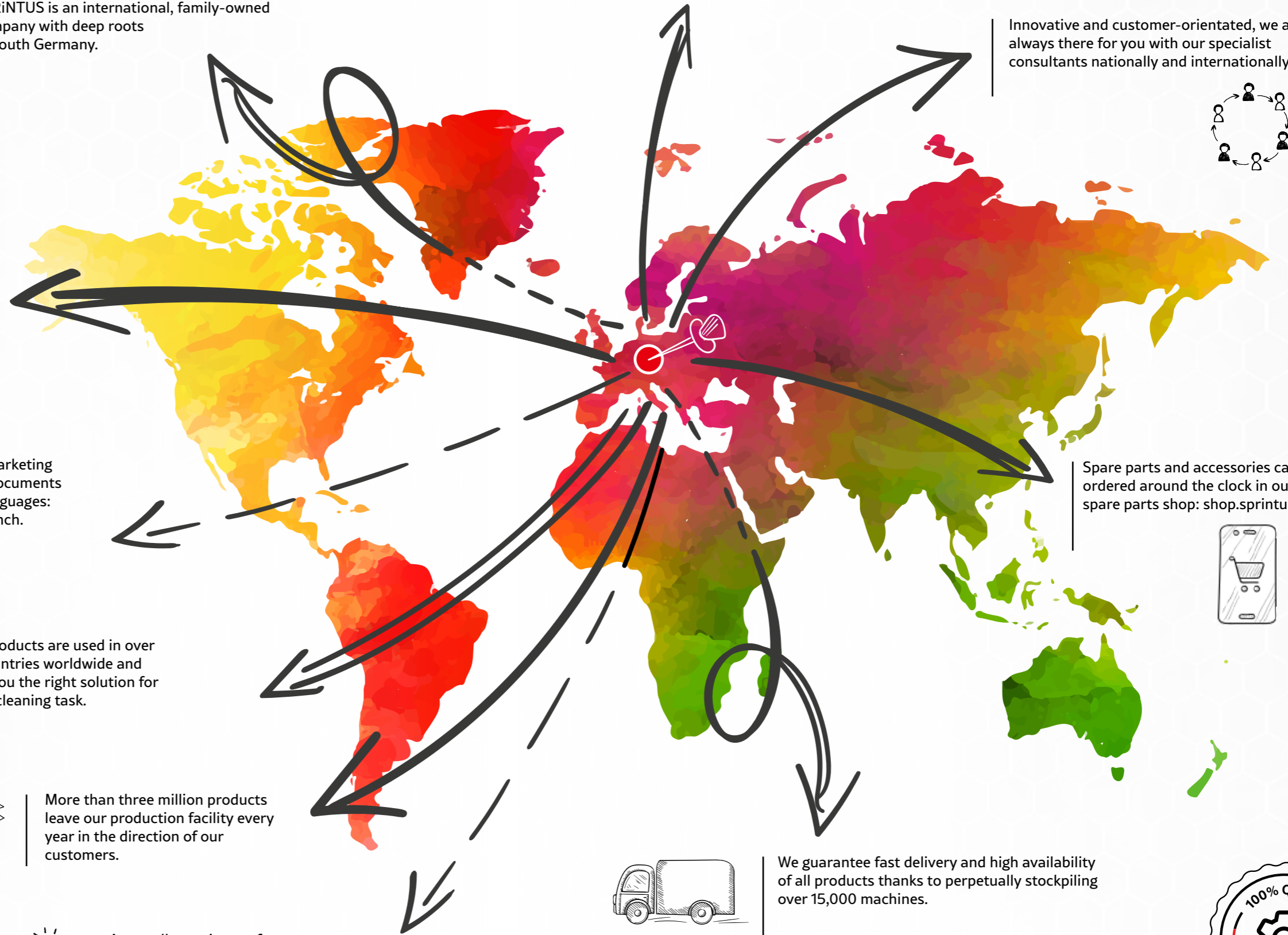

Our digital and analogue marketing materials as well as sales documents are available in multiple languages: in German, English and French.

Spare parts and accessories can be ordered around the clock in our online spare parts shop: [shop.sprintus.eu](http://shop.sprintus.eu)



Our products are used in over 60 countries worldwide and offer you the right solution for every cleaning task.

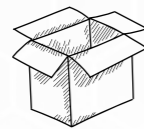

More than three million products leave our production facility every year in the direction of our customers.

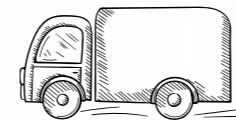

We guarantee fast delivery and high availability of all products thanks to perpetually stockpiling over 15,000 machines.



An excellent price-performance ratio and the best quality – that is our promise to you.





# SUSTAINABILITY

WE BEAR RESPONSIBILITY



As a highly innovative family business, we take responsibility. Both every single of our employees and we as a company. Our environment, resources and society are important to us. That is why we strive every day to handle them sustainably and responsibly. This means taking responsibility in economic, social and ecological terms. We take responsibility for our products, resources, production and supply chain, employees and society. For us, this means above all never standing still, but always being on course for optimization. In February 2024, we were awarded the EcoVadis silver medal for our successful sustainability management.



## Our Product range

Anyone who uses our professional cleaning appliances is already making a significant contribution to sustainability. This is because our product portfolio is designed to clean and thus preserve premises and objects. Our high-quality products save energy, conserve resources and are particularly quiet. At the same time, they achieve perfect cleaning results. Thanks to a multiple filtration system, including HEPA 13 filter cartridge, filter basket and filter bag in our ERA model range, they guarantee extremely clean blow-out air and protect the user and anyone in the vicinity.



## Our Products

When developing and designing our products, their outstanding quality and functionality comes first. At the same time, we place great importance in making them as sustainable and resource-saving as possible.

Already today, the proportion of recycled plastic in our Floory and our ERA model series is up to 75 %. In the future, we will consistently reduce the proportion of new plastics in our products and, while maintaining the quality and functionality of our products, replace them with recyclate plastic.

We also offer selected products with financial climate contribution on request. For these, we have carried out a calculation of CO<sub>2</sub> emissions based on the Greenhouse Gas Protocol and offset them by supporting internationally recognised climate protection projects.

In addition to the compact, ergonomic and lightweight design, the durability of our extremely robust and resistant products also plays an important role in terms of sustainability. Strict test procedures ensure an extra long service life of the motor.

With the efficient and energy-saving 700 watt motors of the ERA TEC and ERA PRO, our customers benefit from an extremely low sound pressure level of only 49 [dB]. With the powerful cordless dry vacuum cleaner ERA iGO, equipped with two 18V batteries and a 300W EC motor, the sound pressure level is only 55 [dB].

Right from product development, we make sure that repairs are easy to carry out. For this purpose, we also offer our customers rapid spare parts availability within 48 hours as well as a very wide range of spare parts. However, sustainability plays an important role not only in the development and production of products but also in their disposal. Our products are therefore made of recyclable materials.



## Our Resources

We pursue the goal of minimising our ecological footprint. That is why we use our finite resources as efficiently as possible and at the same time rely on renewable energies. Our photovoltaic system at our company location in South Germany produces approx. 550 MWh of electricity per year. In 20 years, the plant will save as much CO<sub>2</sub> as 2,671 beech trees store over the course of 55 years. Our customers and employees also have their own charging stations at their disposal, where they can charge their electric vehicles for free. Our location is also equipped with LED lighting and we attach great importance to the use of green electricity.

Through increasingly digital conferences, we are reducing business travel to a minimum and thus also the greenhouse gas emissions caused by train, car and plane. We reduce product packaging to the bare essentials, rely primarily on cardboard packaging material and avoid packaging waste from local suppliers to the furthest extent possible, for example, by using special transport boxes. As part of the delivery to our customers, we pay attention to a 100% climate-neutral parcel shipping.





## Our Production

**A**s a German company, we are very proud to manufacture our top products at our headquarters in Germany. By moving into our new assembly and logistics center, we can expand our production and logistics area to a total of 10,000 m<sup>2</sup>. This will guarantee us the spatial growth opportunities for the coming years at our headquarters. In addition, the majority of the added value of our entire product range is created at our German headquarters, from the development of our products to marketing and sales. We maintain long-standing relationships and reliable, honest partnerships with our suppliers. When selecting our suppliers, they undergo a careful assessment with regard to social and ecological factors.

## Our Employees

**W**ith indispensable expertise and passion, our employees are committed to our company and our customers every day. They have made SPRINTUS and its high-quality innovative products what they are today. As a company, we bear responsibility for our employees, the most important asset of our company. We guarantee secure jobs through successful products and responsible action and do everything we can to ensure the best possible working environment, regardless of if this concerns further training opportunities, the compatibility of work and family or the health of our employees. Ergonomic, modern workplaces are a matter of course for us. For a positive working atmosphere, regular team building measures and company events are important to us. As an expanding family business, we are pleased to count numerous long-standing employees.

## Our Company

**W**ith the action we take on the entrepreneurial level, we bear far more responsibility than just for SPRINTUS as a company and our employees. Sustainable action has an impact across company and national borders. That is why we take responsibility for the entire society.

## Our Sustainability goals

**F**or us, assuming responsibility in ecological, social and economic terms means always being on course for optimisation. We are not only a company with financial climate contribution, but also offer sustainable products. On the basis of a holistic climate strategy, we were able to carry out a comprehensive analysis of the carbon footprint of our company and selected products. Subsequently, measures were taken to reduce and offset CO<sub>2</sub> emissions by supporting internationally recognised climate-protection projects. In February 2024, we were awarded the EcoVadis silver medal for our sustainability successes. We would like to continue to face up to this globally recognized sustainability rating in the future.



# CLIMATE CONTRIBUTION

We offer on request  
**products with financial  
 climate contribution.**

For selected products, in accordance with the Greenhouse Gas Protocol we have also determined the CO<sub>2</sub> emissions on the basis of the “Cradle-to-customer plus end-of-life” approach. This takes into account all emissions from the extraction and preparation of the raw materials and packaging, the production and delivery of the product to the customer’s factory gate and relevant emissions from the disposal of the product and the packaging.

**B**ased on this calculation, from now on, when you purchase selected products, you will have the choice of purchasing them as products with financial climate contribution. We take care of offsetting the emissions concerned. In the catalogue, the products are marked with the “Available with financial climate contribution” icon. We offer the following products.



## Dry vacuum cleaners:



Floory **ZERO**  
 (page 22 + 38)

ERA EVO **ZERO**  
 (page 26 + 38)

ERA TEC **ZERO**  
 (page 28 + 38)

ERA PRO **ZERO**  
 (page 30 + 38)

ERA iGO **ZERO**  
 (page 34 + 38)

## Mop covers:



Basic PRO **ZERO**, 40 cm  
 Basic PRO **ZERO**, 50 cm  
 (page 135)

Premium PRO **ZERO**, 40 cm  
 Premium PRO **ZERO**, 50 cm  
 (page 135)

Classic PRO **ZERO**, 40 cm  
 Classic PRO **ZERO**, 50 cm  
 (page 135)

Excellent **ZERO**, 40 cm  
 Excellent **ZERO**, 50 cm  
 (page 137)

By purchasing products with financial climate contribution, you are making a contribution to global climate protection and supporting recognised climate protection projects. You are also supporting the achievement of global sustainability targets (sustainable development goals) such as combating poverty and improving living conditions in threshold and developing countries.

**F**or us, taking responsibility means developing and producing sustainable resource-saving products. We produce our top products at our company headquarters in Germany. Moreover, we make sure to use our resources as efficiently as possible and at the same time rely on renewable energies.

In our view, the move towards offsetting, in addition to avoiding and reducing emissions, is a crucial step in climate action. So we have determined the CO<sub>2</sub> emissions for our company and selected products. Based on this, we have taken measures to avoid and reduce them. We have been able to offset unavoidable emissions thanks to the support of internationally recognised carbon offset projects. In this context, we work together with [ClimatePartner](#).

We are a company with  
**financial climate contribution.**



We have determined our company’s CO<sub>2</sub> footprint in accordance with the guidelines of the Greenhouse Gas Protocol. Here the total emissions were divided into three categories (scopes).

**Scope 1** consists of all emissions directly generated by our company, for example by our company’s own vehicle fleet.  
**Scope 2** covers emissions arising from purchased energy such as electricity, whereas  
**Scope 3** covers indirect emissions such as the employees’ commute to work.





## Reforestation in Nicaragua

Forests form the basis of our lives and are among the most important CO<sub>2</sub> reservoirs on the planet. This project in eastern Nicaragua has reforested 2,361 hectares with more than one million plants of a native bamboo species and protects an additional 1,000 hectares of ancient forest. A highly degraded landscape has thus been transformed into a diverse ecosystem in order to curb global warming.

## We support certified climate protection projects

Greenhouse gases such as CO<sub>2</sub> spread evenly in the atmosphere. So the concentration of greenhouse gases is about the same all over the earth. Emissions that cannot be avoided locally may be offset by climate protection projects at another location. These significantly reduce greenhouse gases and make a major contribution to combating global warming. To offset our CO<sub>2</sub> emissions, we support the following recognised climate protection projects that are certified according to international standards.

## Renewable energies in Asia

One-third of global greenhouse gas emissions are caused by burning fossil fuels such as coal and oil. These fossil fuels are not only finite, but also have serious effects on the climate. In order to reduce CO<sub>2</sub> emissions and meet the growing demand for energy, the promotion of renewable energy sources is essential. On the Asian continent, we support a portfolio of climate protection projects to drive the expansion of wind and solar energy, hydropower, as well as biogas and biomass.



### ERA TEC / ERA PRO in ECO-Modus

Example calculation:

Number of vacuum cleaners per fleet	100
Input power (W)	250
Working days per annum	220
Operating time per day (h)	3
Energy costs per kWh* (€)	0,41
CO <sub>2</sub> emission per kWh** (g)	380
<hr/>	
Annual energy saving compared with a traditional vacuum cleaner fleet***	42.900 kWh
Annual energy cost saving compared with a traditional vacuum cleaner fleet*** (= Energy saving * Energy costs)	17.740 €
Annual CO <sub>2</sub> saving* compared with traditional vacuum cleaner fleet	16,3 t

## ENERGY COSTS CALCULATOR

With SPRiNTUS dry vacuum cleaners you will impress your customer with extremely low energy costs on his premises. At the same time, you will be automatically making a contribution to reducing CO<sub>2</sub> emissions. The ERA TEC and ERA PRO dry vacuum cleaners have a continuous electronic power control. So in ECO mode they can work with input power of only 250 Watts.

The use of a fleet of 100 ERA TECs or ERA PROs in ECO mode delivers the following maximum potential savings compared with the use of 100 traditional 900-Watt vacuum cleaners:

A fleet of 100 ERA TECs or ERA PROs provides a **maximum annual saving of € 17,740 and 16,3 tonnes of CO<sub>2</sub>** compared with the use of 100 traditional 900 Watt vacuum cleaners.

- \* Source: Electricity cost per kWh in July 2024 per Bundesverband der Energie- und Wasserwirtschaft (Federal Association of the Energy and Water Industries).
- \*\* Source: Greenhouse gas emissions in the German electricity mix in 2023 per Umweltbundesamt (Federal Environmental Agency)
- \*\*\* Traditional vacuum cleaners with 900 Watts.



 YouTube  
**VIDEOS**

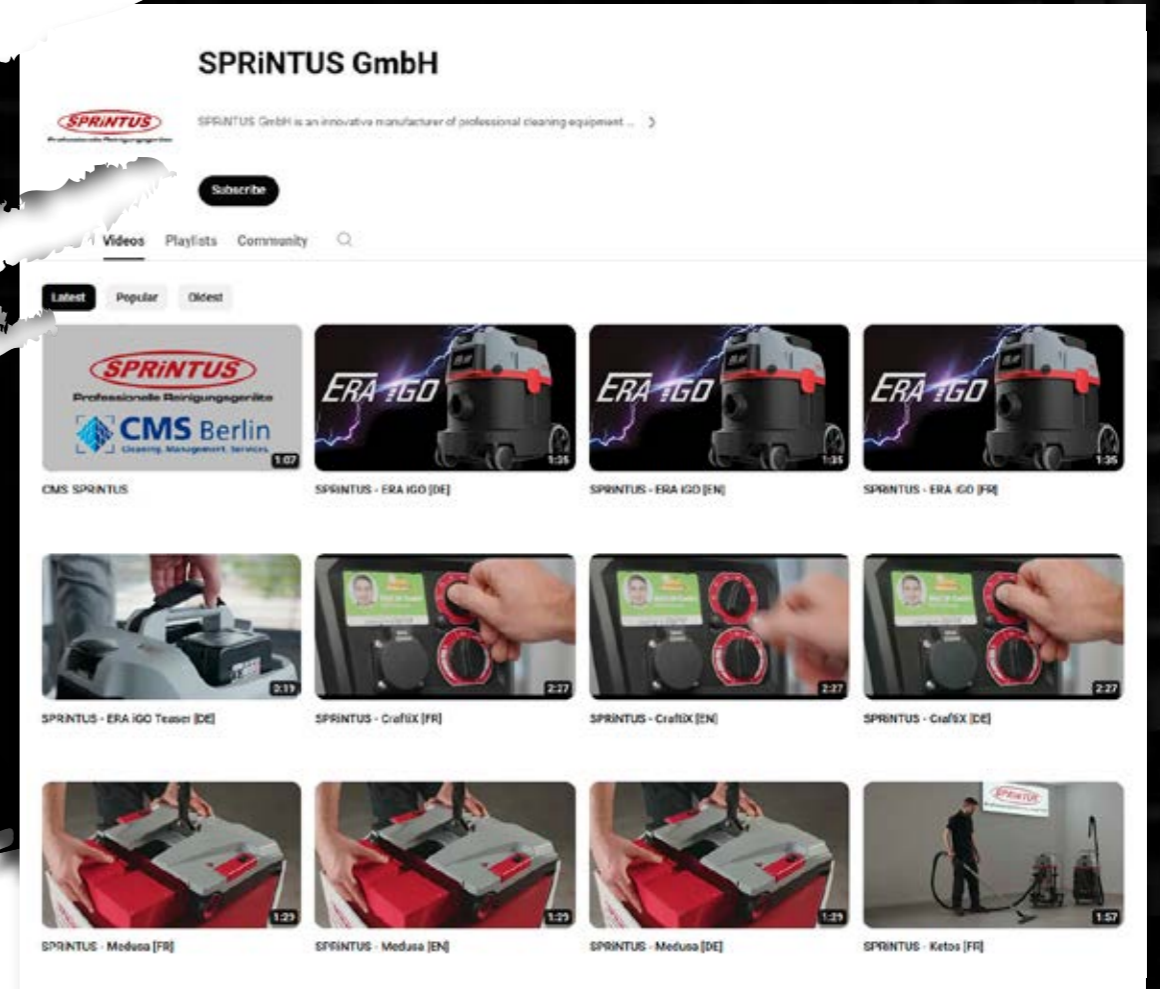

Discover our professional videos on

 **YouTube**

Here you will find an overview of the most important features of a large number of our products and experience them in action.



SPRINTUS GmbH

*WATCH OUR FILMS!*

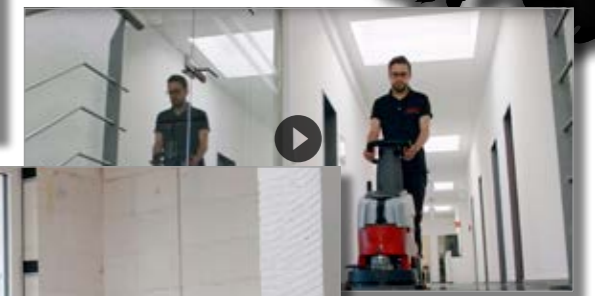



VISIT OUR  
WEBSITE



[www.sprintus.eu](http://www.sprintus.eu)

- ➔ Optimised for desktop PC, notebook, tablet and smartphone.
- ➔ 3D images with hotspots.

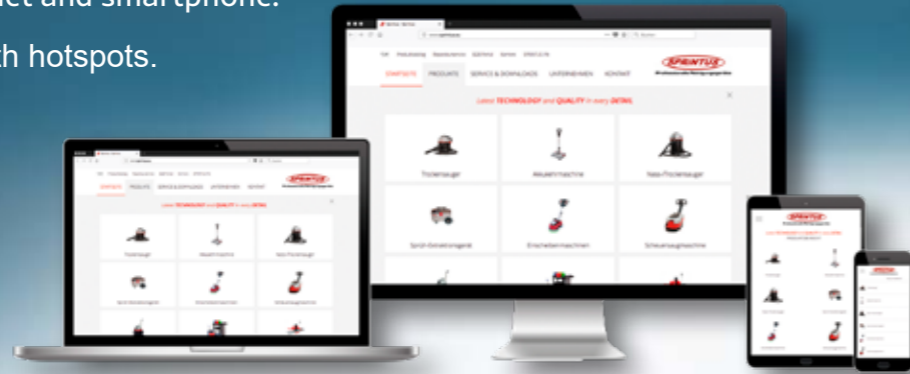

Whether it's about new products, trade fairs and events or insights behind the scenes at **SPRiNTUS**, subscribe to our social media channels and

**ALWAYS BE UP TO DATE!**



 YouTube



 facebook



 Instagram



 LinkedIn

- ➔ Order spare parts and accessories in our online shop.
- ➔ Fast delivery, easy payment.
- ➔ Around the clock.



[shop.sprintus.eu](http://shop.sprintus.eu)





# CONTENT

## 20 Dry vacuum cleaners

ARES	20
FLOORY	22
ERA-SERIES	24
ERA EVO	26
ERA TEC	28
ERA PRO	30
ERA IGO	34
ZERO DRY VACUUM CLEANERS	38
MAXIMUS PT	40

## 42 Backpack vacuum cleaner

BOOSTIX / BOOSTIX IGO	42
-----------------------	----

## 46 Accessories dry vacuum cleaners

OVERVIEW SUCTION NOZZLES	46
--------------------------	----

## 48 Battery-sweeper

MEDUSA / MEDUSA SET	48
---------------------	----

## 50 Wet and dry vacuum cleaners

ARTOS	50
WATERKING-SERIES	52
WATERKING, WATERKING XL	
N-SERIES	56
N 55/2 E, N 77/3 E, N 80/2 K	
KETOS-SERIES	60
KETOS 56/2 K, KETOS 81/2 K	

## 64 Pump/ Fire service vacuums

N 51/1 KPS	64
HEROS	66

## 68 Safety vacuum cleaners

CRAFTIX-SERIES	68
CRAFTIX 35 L, M, H & 50 L, M, H	

## 78 Accessories wet and dry vacuum cleaners

OVERVIEW SUCTION NOZZLES	78
--------------------------	----

## 80 Single disc/orbital machines

EM 17 EVO	80
HERCULES	82
HERCULES DUO SPEED	84
ZEUS	86
EEM 13 R	88
TITAN	90

## 92 Floor scrubber dryers

TORANA	92
CAMIRA	96

## 100 Accessories

OVERVIEW BRUSHES AND PADS	100
---------------------------	-----

## 104 Spray-extraction cleaner

SE 7	104
------	-----

## 106 Overview accessories

CONSUMABLES AND ACCESSORIES FOR ALL MODELS	106
--	-----

## 112 Rolling buckets

SINGLE AND DOUBLE ROLLING BUCKETS	112
WARNING SIGNS	113
COMBIX-SERIES	114
MINI, COMBIX, XL, PRO	

## 116 Cleaning trolleys

PURIX	116
PURIX PRO	118
MATRIX-SERIES	120
PRESS, BOX	
VARIX-SERIES	122
VARIX, PRESS, BOX, BOX-COMPACT	

## 128 Manual cleaning

MAGIC CLICK	128
ECO & V-WING MOP HOLDERS	130
ALUMINIUM HANDLES	131
MOP COVERS	132
RAINBOW MICROFIBER CLOTH	140

## 142 Your brand

MOP COVER, MACHINES	142
---------------------	-----

## 144 SPRiNTUS.life

CLICK TO MOP	145
CLICK 'N' PRESS	146
CLICK 'N' TWIST	148





# ARES

The entry-level of the professional dry vacuum cleaners.



- ① Tool-free exchange of engine filter
- ② Washable fleece filter basket
- ③ Tearproof, closable fleece filter for optimal dust intake
- ④ Comfortable suction-hose-click-system
- ⑤ Large back wheels for high stability
- ⑥ Standard 2in1 crevice-/upholstery nozzle



**Optional accessories:**



Parquet nozzle 360 mm horsehair. Item-no. 111207

Tool-free exchange of horsehair strips. Item-no. 101104

The ARES, the compact entry-level model of the SPiRiNTUS energy dry vacuum cleaners, convinces with its agility and quality, which clearly distinguish the ARES from other entry-level vacuum cleaners. A high suction power and an efficient 700 watt engine are must-haves for SPiRiNTUS vacuum cleaners and allow the compact and reliable ARES to be a dynamic partner in the professional cleaning industry. Part of the extensive equipment are high quality aluminium tubes, which are in accordance with the high SPiRiNTUS quality standards. The robust, 2,0 m long Memory-Flex vacuum hose and a 8 m power cord, ensure an operating radius of 10 m. Due to the standard 2in1 crevice and upholstery nozzle, even hard to reach places and delicate areas can be cleaned. Thanks to its compact size and extensive equipment, the SPiRiNTUS ARES is a versatile dry vacuum, which can take on even larger cleaning challenges.



Standard parking position of the energy combi nozzle.

TECHNICAL DATA	
Voltage	220-240 V / 50 Hz
Max. Power	700 W
Max. negative pressure	210 mbar*
Volume flow	40 Litres / sec.
Sound pressure level	64 LpA [dB]
Container material	plastic
Container volume	10 Litres (gross)
Filter bag volume	7,5 Litres
Length of power cord	8 m
Length of suction hose	2,0 m
Diameter of suction hose	32 mm
Diameter of suction tube	32 mm
Weight	4,2 kg
Dimensions (L x W x H)	34 x 33 x 31,5 cm

\*Measured at the nozzle



Two parking positions at the back of the machine for the crevice-/upholstery nozzle or the aluminium tubes.

	Item-no.	UK	EU
<b>ARES</b>		115003	115001
incl. 3 x aluminium tube ø 32 mm, suction hose 2,0 m, fleece filter basket, 1 x fleece filter bag, 2in1 crevice-/upholstery nozzle, energy combi nozzle 265 mm and power cord 8 m, black			
<b>STANDARD KIT:</b>			
Aluminium tube 0,5 m (1 piece),			106026
Suction hose complete, 2,5 m			114113
Energy combi nozzle			114114
Fleece filter basket			115118
Power cord 8 m, black	115128		115115
2in1 crevice-/upholstery nozzle			115127
<b>ACCESSORIES:</b>			
Fleece filter bags (10 pieces)			115113
Telescopic tube, stainless steel, 0,6-1,0 m			117228
Vacuum hose, 3 m, antistatic			109111
Handle, antistatic with connection sleeve			117148
<b>ACCESSORIES OVERVIEW, see page 46, 47 and 106.</b>			



# FLOORY

A top machine with an attractive price – swift, compact and reliable.

## MADE IN GERMANY



The powerful and energy-saving 700 watt engine ensures an excellent suction power at a low noise level and highly efficient dirt absorption with its 11 l container volume.

As with all other SPRINTUS products, the design and development are of high quality and practical in every detail. With our FLOORY, the user receives a perfect all-round package, a reliable and economic partner for hard floors and carpet. Aluminium tube, elastic bumpers and easy emptying. The 10 m power cord and the 2 m step resistant suction hose without memory effect ensures maximum maneuverability.



HEPA13 fleece filter basket as standard for bagless vacuuming.  
Item-no. 114118

HEPA 13 fleece filter bag.  
Item-no. 106061

2in1 crevice-/ upholstery nozzle.  
Item-no. 115127



Closable, voluminous cable hook.



Power regulation adjustable to all types of surfaces.



Large foot switch for turning on and off without bending down.



Maximum ergonomics: with a weight of only 4,2 kg, the Floory can comfortably be carried with one hand.

### TECHNICAL DATA

Voltage	220-240 V / 50 Hz
Max. Power	700 W
Max. negative pressure	210 mbar*
Volume flow	38 Litres / sec.
Sound pressure level	60 LpA [dB]
Container material	plastic
Container volume	11 Litres (gross)
Filter bag volume	7 Litres
Length of power cord	10 m
Length of suction hose	2,5 m
Diameter of suction hose	32 mm
Diameter of suction tube	32 mm
Weight	4,2 kg
Dimensions (L x W x H)	35 x 29 x 38 cm

\*Measured at the nozzle



Large wheels with spoke design.



Robust running castors with bumpers.



Improved comfort: Pluggable 10 m device cable for easy cable change.

Four accessories slots on the back. Parking position for optional turbo brush or parquet nozzle.

### Optional accessories:

Parquet nozzle  
360 mm horsehair.  
Item-no. 111207

Tool-free exchange of horsehair strips.  
Item-no. 101104

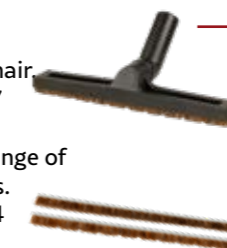

Item-no. UK EU

**FLOORY FLOORY ZERO** 114051 114050  
Z114050

incl. 2 x Aluminium tube ø 32 mm, 2,5 m suction hose, 1 x HEPA13 fleece filter bag, HEPA13 Fleece filter basket, energy combi nozzle 280 mm, 2in1 crevice- / upholstery nozzle, 10 m power cord, pluggable, black

### STANDARD KIT:

Aluminium tube, 0,5 m (1 piece)	106026
Suction hose complete, 2,5 m	114113
Energy combi nozzle 280 mm	114114
2in1 crevice- / upholstery nozzle	115127
HEPA13 fleece filter basket	114118
Power cord 10 m, black	114124 111128

### ACCESSORIES:

Fleece filter bags (10 pieces)	106013
Fleece filter bags (250 pieces)	106014
HEPA13 fleece filter bags (10 pieces)	106061
Telescopic tube, stainless steel, 0,6- 1,0 m	117228
Vacuum hose, 3 m, antistatic	109111
Handle, antistatic with connection sleeve	117148
15 m power cord, pluggable, signal red	119119

ACCESSORIES OVERVIEW, see page 46,47 and 106.



# THE NEW ERA OF CLEANING

## Discover the new age of professional cleaning.

The ERA range sets new standards in the industry and symbolises a new era in professional cleaning. Unprecedented features have been incorporated into the model range, which consists of the three power cord models ERA EVO, TEC and PRO with integrated cable rewind and the ERA iGO cordless vacuum cleaner.

The models differ primarily in terms of their features. In addition to the striking, modern and open design, all models are united by their whisper-quiet operation. The top-of-the-range ERA TEC model boasts unique features such as a USB port including mobile phone charging function and a filter bag reserve compartment. The ERA PRO with integrated touch display is the first to tackle the topic of Industry 4.0 and is the world's first digital dry vacuum cleaner with Bluetooth connectivity and cloud-based fleet management. The cordless ERA iGO guarantees maximum flexibility and mobility. The 36 V Li-ion version combines self-sufficient working with the unique features of the ERA model series.

All four models are produced at the SPRINTUS company headquarters in southern Germany and are characterised by a recycled material content of up to 75 per cent. We not only design and produce the four models as sustainably and resource-efficiently as possible, but also offer you the opportunity to purchase them with a financial climate contribution.

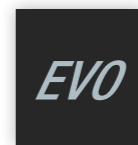

**ERA EVO / ERA EVO ZERO**  
Versatile all-rounder with triple HEPA13 filtration.



**ERA TEC / ERA TEC ZERO**  
Guarantees top performance at an incredibly quiet 49 dB in ECO mode.

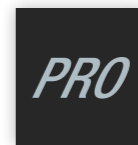

**ERA PRO / ERA PRO ZERO**  
Sets new standards as the world's first digital dry vacuum cleaner.



**ERA iGO / ERA iGO ZERO**  
Wireless, self-sufficient working and maximum flexibility.

*"All four models are produced at the SPRINTUS company headquarters in southern Germany and are characterised by a recycled material content of up to 75 per cent. We not only design and produce the four models as sustainably and resource-efficiently as possible, but also offer you the opportunity to purchase them with a financial climate contribution".*





# ERA EVO The price-performance winner.

The quiet ERA EVO is versatile, compact, reliable and a true powerhouse. The integrated cable rewind makes the safe and practical storage of the signal-red 10m power cord possible. If required, you can change the cable in just a few simple steps and without using any tools.

High-quality filter media, such as the standard fleece filter basket, the HEPA13 filter bag, and the HEPA13 filter cartridge guarantee clean blow-out air at all times and are particularly suitable for those who suffer from allergies or for the cleaning of sensitive areas, such as hospitals, nursing homes and kindergartens. The extra-large, tear-resistant 9-litre fleece filter bag guarantees a high volume of dirt absorption and long working intervals, without frequent and annoying filter bag changes.

The power regulation that can be adjusted on the device allows for the ERA EVO to be adapted to any floor covering. And what's best: already for small order quantities, we equip the ERA EVO with your logo and strengthen your company image and brand.



50%  
RECYCLED  
MATERIAL

Standard operating LED in blue.



Your brand. Your company image. We imprint your logo.



Integrated cable rewind with open design.



Tool-free cable changing.

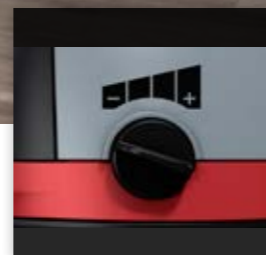

Mechanical power regulation.

## FEATURES

### ERA EVO

#### ERA EVO ZERO

incl. 2 x aluminium suction tubes, suction hose 2,5 m, HEPA 13 fleece filter basket, HEPA 13 fleece filter bag, HEPA 13 filter cartridge, crevice nozzle, 2in1 upholstery nozzle, energy combi nozzle 280 mm, power cord 10 m, plug-in, signal red

#### FLEECE FILTER BAGS:

Fleece filter bag (10 pcs.)  
Fleece filter bag (250 pcs.)  
HEPA 13 fleece filter bag (10 pcs.)

Item-No.	UK	EU
117004	117001	
		Z117001

#### STANDARD ACCESSORIES:

Item-No.	UK	EU
Single aluminium suction pipe, 0,5 m		106026
Suction hose complete, 2,5 m		114113
Energy combi nozzle 280 mm		114114
2in1 Upholstery nozzle 115 mm		117294
Crevice nozzle 230 mm		101023
HEPA 13 fleece filter basket		117101
HEPA 13 filter cartridge		111132
HEPA 14 filter cartridge <b>TIP</b>		111193
power cord 10 m, plug-in, signal red	111177	111310

ACCESSORIES OVERVIEW see pages 46-47 and 106.



Tool-free removable HEPA13 filter cartridge.

**Tipp:** HEPA 14 filter cartridge, optional for all ERA models.



All-round elastic impact edges and a continuous sliding cam ensure a smooth transition over door thresholds.



HEPA13 washable fleece filter basket.



HEPA 13 fleece filter bag.

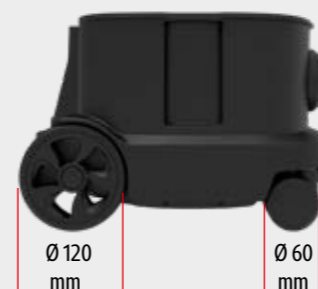

Extra-large wheels and castors ensure a high level of agility and stability.



Tool-free interchangeable motor preselection filter.



Four storage slots for accessories and three parking positions as standard.

MADE IN GERMANY

Available with financial climate contribution ClimatePartner

ZERO



Clean around the clock and at any time of the day.

The ERA TEC is consistently continuing the innovative ERA series, thereby guaranteeing top performance at an incredibly quiet 49 dB in ECO mode. The ERA TEC can therefore be used around the clock, at any time of the day, even in busy and sensitive areas, such as hotels or in office rooms.

Should it be necessary, the spare filter bag compartment saves unnecessary legwork and loss of valuable working time should no replacement filter bags be close at hand.

The standard USB port and the optional storage box allow you to charge your mobile phone directly on the vacuum cleaner without setting aside your mobile anywhere on the property or losing sight of it. Alternatively, the storage box is also suitable as a practical beverage holder, for cleaning agents, or for carrying microfibre cloths.

The fill level indicator in red indicates that the filter bag needs to be changed or clogging.



Telescopic tube, stainless steel (0.6-1.0 m).

50%  
RECYCLED  
MATERIAL

	Item-No.	UK	EU
<b>ERATEC</b>			
<b>ERATEC ZERO</b>		117023	117020
incl. telescopic tube Ø 32 mm, suction hose 2.5 m, HEPA 13 fleece filter basket, HEPA 13 fleece filter bag, HEPA 13 filter cartridge, crevice nozzle, 2in1 upholstery nozzle, energy combi nozzle 280 mm, power cord 12 m, pluggable, signal red			Z117020
<b>FLEECE FILTER BAGS:</b>			
Fleece filter bag (10 pcs.)			106013
Fleece filter bag (250 pcs.)			106014
HEPA 13 fleece filter bag (10 pcs.)			106061

	Item-No.	UK	EU
<b>STANDARD ACCESSORIES:</b>			
Stainless steel telescopic suction tube, 0.6 - 1 m, Ø 32 mm			117228
Suction hose complete, 2.5 m			114113
Energy combi nozzle 280 mm			114114
2in1 Upholstery nozzle 115 mm			117294
Crevice nozzle 230 mm			101023
HEPA 13 fleece filter basket			117101
HEPA 13 filter cartridge			111132
HEPA 14 filter cartridge <b>TIP</b>			111193
power cord 12 m, plug-in, signal red		111177	117133

ACCESSORIES OVERVIEW see pages 46-47 and 106

## Features additional equipment for the ERA TEC

### FEATURES

Additional equipment for the ERA TEC



Fill level indicator LED, red.



Operating LED, blue.



Clever filter compartment for spare filter bags.



Infinitely adjustable ECO mode.  
100 % LpA: 54 LpA [dB]  
50 % LpA: 49 LpA [dB]

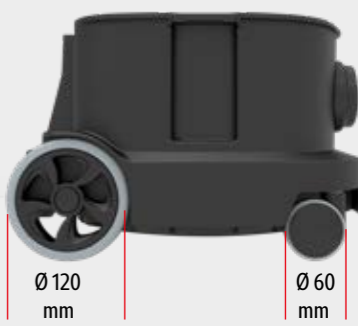

Extra-large rubberised wheels and castors.



Optional storage box including 3in1 charging cable. ERA PRO standard features. Item-no. 117111

MADE IN GERMANY

Available with financial  
climate contribution  
ClimatePartner



# ERA PRO

## The world's first dry vacuum cleaner that rises to the challenges of Industry 4.0.

With the first-time digitisation of commercial dry vacuum cleaners, the ERA PRO dry vacuum cleaner by SPRINTUS sets new benchmarks in professional cleaning.

The interactive touch display can be customised with your logo using the SPRINTUS APP. In this way, new customers can be acquired, and the corporate design can be adapted and underscored.

A language selection (EU, ENG, FR, IT) can be made. In the event of a fault, solution suggestions are shown on the display. In combination with the integrated Bluetooth interface, important device data such as operating hours, daily run time, location data can be transferred into the cloud-based fleet management and connected to commonly used ERP systems. Run times can be checked with the touch of a button, and property calculations can be adapted. In the display, additional data can be stored and called up, e.g. property, user and customer data. The user can call up spare parts drawings, user manuals, data sheets and other device data at any time.



	Item-No.	UK	EU
<b>ERA PRO</b>		117045	117040
<b>ERA PRO ZERO</b>			Z117040
incl. interactive touch display, telescopic tube, 2.5 m suction hose, HEPA 13 fleece filter basket, HEPA 13 fleece filter bag, HEPA 13 filter cartridge, crevice nozzle, 2in1 Upholstery nozzle, energy combi nozzle 280 mm, power cord 12 m, plug-in, signal red			
<b>ERA PRO Komfort set</b>			117041
incl. 280 mm electric suction brush			
<b>FLEECE FILTER BAGS:</b>			
Fleece filter bag (10 pcs.)			106013
Fleece filter bag (250 pcs.)			106014
HEPA 13 fleece filter bag (10 pcs.)			106061

ACCESSORIES OVERVIEW see pages 46-47 and 106.

	Item-No.	UK	EU
<b>STANDARD ACCESSORIES:</b>			
Stainless steel telescopic suction tube, 0.6 - 1 m			117228
Suction hose complete, 2.5 m			114113
Energy combi nozzle 280 mm			114114
2in1 Upholstery nozzle 115 mm			117294
Crevice nozzle 230 mm			101023
HEPA 13 fleece filter basket			117101
HEPA 13 filter cartridge			111132
HEPA 14 filter cartridge <b>TIP</b>			111193
power cord 12 m, plug-in, signal red	111177		117133
<b>OPTIONAL ACCESSORIES:</b>			
Electric suction brush 280mm			111135

### ERA MODEL COMPARISON

Technical data	ERA EVO	ERA TEC	ERA PRO
Voltage	220-240 V / 50 Hz		
Performance	700 Watt		
Max. negative pressure	210 mbar*		
Volume flow	38 Litres / sec.		
Sound pressure level	55 LpA [dB]	49 - 54 LpA [dB]	
Container material	Kunststoff		
Container volume	13 Liter (brutto)		
Filter bag volume	9 Liter		
Length of power cord red, pluggable	10 m	12 m	12 m
Hose length	2,5 m	2,5 m	2,5 m
Suction hose ø	32 mm		
Suction pipe ø	32 mm		
Device weight	5,1 kg	5,5 kg	5,7 kg
Dimensions	38 x 28 x 43 cm		
Equipment	ERA EVO	ERA TEC	ERA PRO
Aluminium suction pipe 2 x 0.5 m	●	-	-
Telescopic tube 0.6-1m	○	●	●
Energy combi nozzle	●	●	●
Crevice nozzle	●	●	●
2in1 Upholstery nozzle	●	●	●
Cable winder	●	●	●
HEPA 13 filter basket	●	●	●
HEPA 13 filter cartridge	●	●	●
HEPA 14 filter cartridge	○	○	○
HEPA 13 filter bag	●	●	●
Filter bag reserve compartment	○	●	●
Rubberised wheels / castors	-	●	●
USB charging function	-	●	●
Storage box	○	○	●
Charging cable for mobile phone	-	○	●
Bluetooth	-	-	●
Touchdisplay	-	-	●
Mechanical power control	●	-	-
ECO mode power regulation	-	●	●
Operating indicator (blue LED)	●	●	●
Blockage indicator (red LED)	-	●	●

● Standard equipment ○ optional \*Measured at the nozzle



## FEATURES

### Additional equipment for the ERA PRO



Interactive touch display with current date and time.



3in1 Charging cable. Item no. 117123



Socket for optional electric vacuum brush. Item-no. 111135



Storage box. Item no. 117116



Individualisation via SPRINTUS APP in seconds.



Read out/synchronise device data via Bluetooth interface.



Output of faults and maintenance instructions.



Individual language selection.



Via the interactive touch display, run times, faults, maintenance activities, as well as the date and time can be read. The home screen is individually adjustable. For example, property and user data can be continuously input and displayed.







## Web portal

SPRINTUS browser-based fleet management system allows you to centrally manage all ERA PRO dry vacuum cleaners and keep an eye on everything at all times. In the general overview, all basic information concerning your ERA PRO is shown in a compact manner. You can call up data relevant for each ERA PRO, such as location, property names, users, daily run times, maintenance dates, such as the DGUV V3 for example, or faults at any time. With the synchronisation via the SPRINTUS APP, all data is displayed in real time in the web portal.

### Reports

In the detail view, you have access to all relevant reports concerning your ERA PRO. This helps you to make the right decisions and keep your fleet in optimal operational condition. Other cleaning equipment located on the property can be created and be centrally managed via the web portal.

### Your advantages at a glance:

- Overview of the status and run times of all devices
- Faults and maintenances are displayed individually
- Visualisation of the devices by map on a property basis
- Extensive software functions and reports
- Professional, customisable interface for all common ERP systems

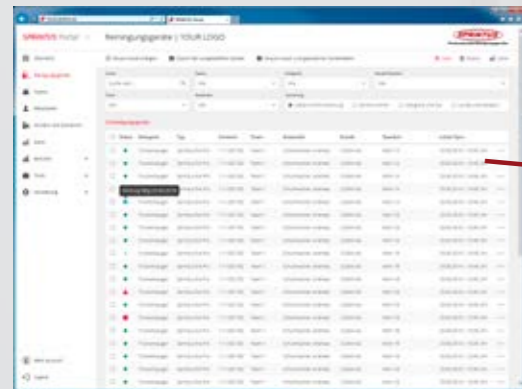

Overview of all devices, including location, status messages and user information.

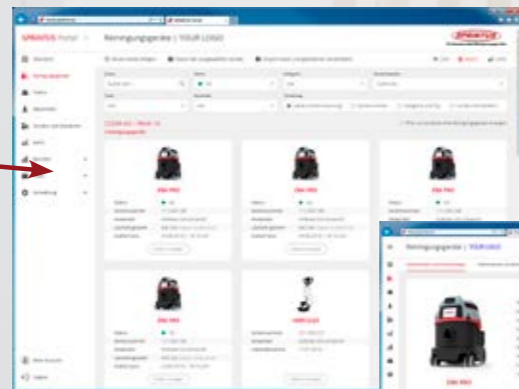

Cleaning equipment detailed overview.

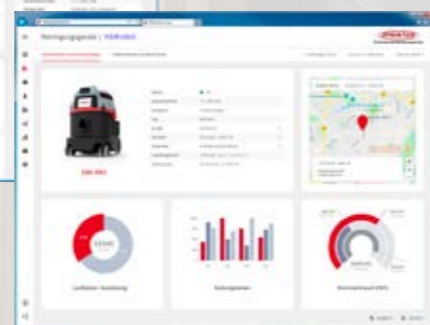

Detailed view of a device: Usage times, run times, location

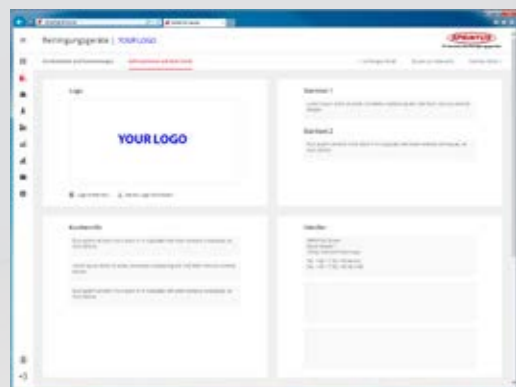

Your own logo and texts can be changed directly on the device.

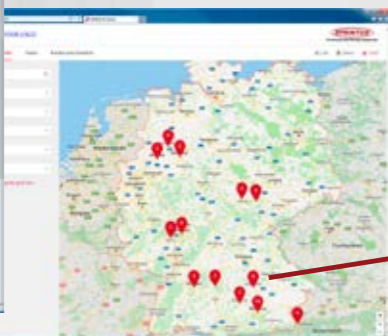

Cleaning equipment, teams, customers, and locations can be displayed on the map.

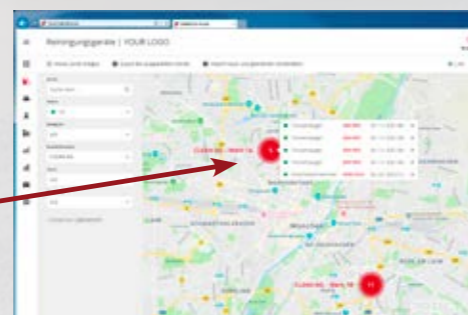

Detailed map view



### The new generation of brush vacuum cleaners:

Unbeatable comfort! The ERA PRO in combination with the electric suction brush achieves excellent results on carpets and carpeted floors. Thanks to its permanent-magnet electric drive and high-level vacuum, it cleans deeply and gently. The carpet is literally combed out by the rotating brush and dirt is transported towards the suction nozzle and sucked in. Even tenacious dirt in the carpet, such as hair or threads, is absorbed. With the remote control on the Ergo handle, you can conveniently switch the brush on and off at the touch of a button. Thanks to the stainless-steel telescopic tube, the working height can be conveniently adjusted to any user and makes it possible to work efficiently and free of fatigue.

The figure shows an ERA PRO set including an electric vacuum brush.



**TIP** ERA PRO-Set including an electric vacuum brush. Item-no. 117041



# ERA iGO

Cordless, 55 [dB] silent dry vacuum cleaner as 36 V Li-Ion version

High-quality HEPA 13 filter media constantly guarantee clean blow-out air and are suitable for persons suffering from allergies as well as for cleaning sensitive areas such as hospitals, care centers or kindergardens.

**MADE IN GERMANY**

Available with financial climate contribution  
ClimatePartner

50% RECYCLED MATERIAL

**ZERO**



HEPA 13 filter cartridge.  
**TIP** HEPA 14 optional.  
Changeable without any tools.



Motor protection filter.



HEPA 13 fleece filter basket.

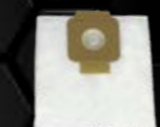

HEPA 13 fleece filter bag.

4 accessory slots and 3 standard parking positions.



The innovative cordless dry vacuum cleaner ERA iGO guarantees maximum flexibility and mobility. The 36 V Li-Ion version combines cordless and self-sufficient work with the unique features of the ERA model series.

The vacuum cleaner is provided with two 18 volt rechargeable batteries and a 300 watt EC motor, enabling excellent cleaning results. The 7,5 Ah batteries connected in series guarantee self-sufficient work of up to 90 minutes.

The power between 150 - 300 watts can be manually adjusted. Thus, the vacuum suction can be easily customized to the corresponding floor covering at any time.



Double - fast charger.  
Charging time 5 Ah batteries approx. 1 hour.  
7.5 Ah batteries approx. 1.5 hours.



Your brand. Your company image.  
We imprint your logo.

Owing to a display on the motor head the power level as well as the battery status can be constantly monitored.

The ERA iGO also impresses with its extremely low sound pressure level of only 60 [dB] or 55 [dB] in ECO mode. This makes it ideally suitable for cleaning heavily frequented areas such as hotels or offices.

The extra-large, tear-resistant 9-liter fleece filter bag guarantees a high dirt absorption capacity and long working intervals avoiding frequent changes of filter bags. In addition, the ERA iGO strengthens your brand and corporate presence thanks to a customizable company logo.

The new cordless dry vacuum cleaner is MADE IN GERMANY. It is manufactured at the SPRINTUS headquarters in southern Germany and can also be purchased as a product with financial climate contribution.





**Features**

Handle including an extendable carrying strap.

Optionally with 2 x 18 V / 5 Ah up to **60 min.** or 2 x 18 V / 7.5 Ah up to **90 min.** or without batteries.

Display indicating remaining time in percent.

LED indicator for blockages.

Variable power regulation from 150 - 300 watts.  
 50% LpA: 55 dB(A)   
 100% LpA: 60 dB(A)

**TECHNICAL DATA**

Voltage	220-240 V / 50 Hz
Max. Power	700 W
Max. negative pressure	160 mbar*
Volume flow	33 Litres / sec.
Sound pressure level	61 LpA [dB]
Container material	plastic
Container volume	11 Litres (gross)
Filter bag volume	9 Litres
Length of power cord	7,5 m
Length of suction hose	2,0 m
Diameter of suction hose	32 mm
Diameter of suction tube	32 mm
Weight	4,9 kg
Dimensions (L x W x H)	29 x 40 x 40,5 cm

\*Measured at the nozzle



The extra storage space for filter bags saves time and enables changing the filter bag, especially when running out of stock.

Extra large rubberized wheels and casters provide high grade agility and stability.

Thanks to the integrated, extendable carrying strap, you can easily carry the lightweight and compact vacuum cleaner over your shoulder especially in confined spaces and stairwells.



The two batteries installed on the motor head create a low center of gravity, which significantly reduces the vacuum cleaner's risk to tip over.

	Item no.
<b>ERA iGO</b> Without batteries and charger incl. telescopic tube Ø 32 mm, suction hose 2 m, HEPA 13 fleece filter basket, HEPA 13 fleece filter bag, HEPA 13 filter cartridge, crevice nozzle, upholstery nozzle, Energy combination nozzle 280 mm	120001
<b>ERA iGO 5 AH</b> <b>ERA iGO 5 Ah ZERO</b> Standard equipment as 120001 additionally 2 x lithium-ion battery 5 Ah and 1 x quick charger	120002 Z120002
<b>ERA iGO 7,5 Ah</b> Standard equipment as 120001 additionally 2 x lithium-ion battery 7,5 Ah and 1 x quick charger	120003
<b>STANDARD ACCESSORIES:</b>	
Telescopic suction tube stainless steel, 0.6 - 1 m, Ø 32 mm	117228
Vacuum hose complete, 2m	114113
Energy combination nozzle 280 mm	114114
Upholstery nozzle 130 mm	117294
Crevice nozzle 230 mm	101023
HEPA 13 fleece filter basket	117101
HEPA 13 filter cartridge	111132
<b>OPTIONAL ACCESSORIES:</b>	
Fleece filter bag (10 pcs.)	106013
Fleece filter bag (250 pcs.)	106014
HEPA 13 fleece filter bag (10 pcs.)	106061
HEPA 14 filter cartridge	111193
Quick charger	119120
Li-ion battery pack 18V, 5 Ah	119121
Li-ion battery pack 18V, 7,5 Ah	119122
<b>ACCESSORIES OVERVIEW, see page 46,47 and 106.</b>	





# ZERO DRY VACUUM CLEANERS

## Sustainable and innovative

Our ZERO dry vacuum cleaners combine a range of exceptional features that make them extremely sustainable, innovative products. ZERO stands for 'zero emission' and means that we minimise the CO<sub>2</sub> emissions caused by our products and offset unavoidable emissions.

In order to significantly reduce the proportion of virgin plastics in our products and thus minimise CO<sub>2</sub> emissions, we use up to 75% recycled plastic in our ZERO dry vacuum cleaners. What's more, all ZERO dry vacuum cleaners are made in Germany! The production of dry vacuum cleaners at our company headquarters in southern Germany enables us to work with regional suppliers, minimise packaging materials and consistently focus on sustainable and resource-saving production.



For each ZERO product, we have determined the CO<sub>2</sub> emissions in accordance with the Greenhouse Gas Protocol using the 'cradle-to-customer plus end-of-life' approach. This approach takes into account all emissions from the extraction and pre-processing of raw materials and packaging, the production and delivery of the product to the customer's factory gate as well as relevant disposal emissions from the product and packaging. This enables us to offset unavoidable emissions by supporting internationally recognised climate protection projects. We work together with **ClimatePartner** for this purpose, and offset the corresponding emissions for you. By avoiding, reducing and offsetting emissions, together we can achieve holistic climate protection. Let's take responsibility together - through the development, production and use of sustainable products!

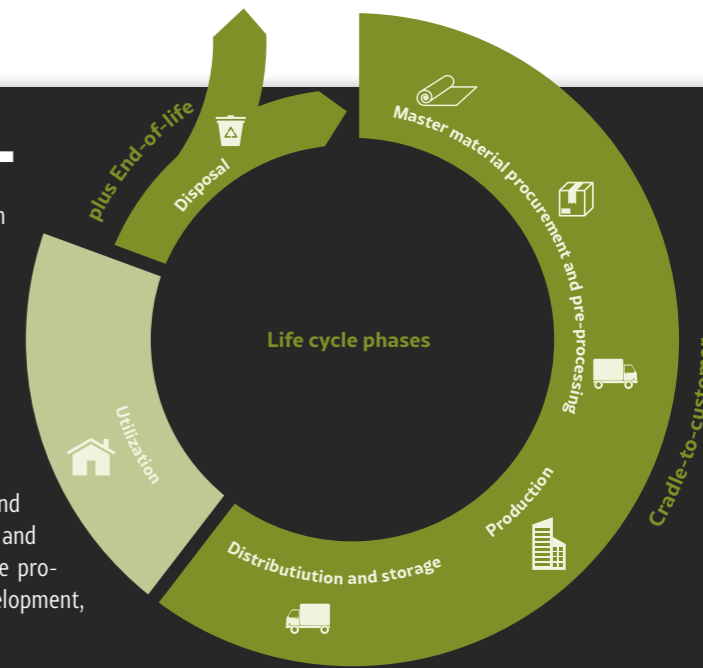

Item-No. **FLOORY ZERO** Z114050  
 incl. 2 x aluminium suction tubes ø 32 mm, 2 m suction hose, 1 x HEPA 13 fleece filter bag, HEPA 13 fleece filter basket, HEPA 13 fleece filter bag, HEPA 13 fleece filter basket, Energy combi nozzle 280 mm, 2in1 Crevice nozzle with brush rim, 10 m power cord, plug-in, black

Item-No. **ERA EVO ZERO** Z117001  
 incl. 2 x aluminium suction tubes ø 32 mm, 2 m suction hose, HEPA 13 fleece filter basket, HEPA 13 fleece filter bag, HEPA 13 fleece filter bag, HEPA 13 filter cartridge, crevice nozzle, 2in1 Upholstery nozzle, energy combi nozzle 280 mm, power cord 10 m plug-in, signal red

Item-No. **ERA TEC ZERO** Z117020  
 incl. telescopic tube ø 32 mm, suction hose 2.5 m, HEPA 13 fleece filter basket, HEPA 13 fleece filter bag, HEPA 13 filter cartridge, crevice nozzle, 2in1 Upholstery nozzle, energy combi nozzle 280 mm, power cord 12 m, plug-in, signal red

Item-No. **ERA PRO ZERO** Z117040  
 incl. interactive touch display, telescopic tube ø 32 mm, 2.5 m suction hose, HEPA 13 fleece filter basket, HEPA 13 fleece filter bag, HEPA 13 filter cartridge, crevice nozzle, 2in1 Upholstery nozzle, energy combi nozzle 280 mm, power cord 12 m, plug-in, signal red

Item-No. **ERA iGO 5AH ZERO** Z120002  
 without batteries and charger incl. telescopic tube ø 32 mm, suction hose 2 m, HEPA 13 fleece filter basket, HEPA 13 fleece filter bag, HEPA 13 filter cartridge, crevice nozzle, 2in1 Upholstery nozzle, energy combi nozzle 280 mm



Product with financial climate contribution  
 ClimatePartner.com/17872-2210-1001

Product with financial climate contribution  
 ClimatePartner.com/17872-2210-1002

Product with financial climate contribution  
 ClimatePartner.com/17872-2210-1003

Product with financial climate contribution  
 ClimatePartner.com/17872-2210-1004

Product with financial climate contribution  
 ClimatePartner.com/17872-2309-1001



# MAXIMUS pt

High-performance dry vacuum cleaner with an automated power socket for electric tools.



## Suggested Use

The Maximus pt is the ideal companion for any construction craftsmen. With its compact dimensions and low weight, it is perfect for electricians, carpenters or exhibition builders. Wherever a handy, lightweight device is required for fast working. Its enormous suction power guarantees a clean, dust-free workplace on location or in the shop. Any power tool can be plugged into the Maximus pt through the standardized socket & rubber

adaptor. The automated socket then activates the vacuum simultaneously with the connected tool. For example when drilling, the vacuum automatically shuts down when the drill is switched off. The included 360 mm floor nozzle ensures performance on a wide range of hard floor and carpeted surfaces. The Maximus pt is universally usable for dry dust and can also be operated without the filter bag.

## Features

- Enormous suction power
- Large operating radius with 7.5 m power cord and 2.5 m hose
- redary joint on the vacuum hose for hindrance-free maneuvering
- Built-in output regulator automatically adjusts to the type of surface
- Mess-free waste disposal with the sealable fleece filter bag
- Additional fine dust filtration possible with the HEPA13 filter cartridge
- Light weight for convenient, single-handed transport
- Accessories storage on the device
- 230 Volt power socket up to 1500 watts with automatic activation
- Large, lockable cable hook



With the multi-tiered power tool adaptor, the vacuum hose can be fitted to any diameter. For example: portable circular saws.



Automated power socket for the use of power tools.



Maximum ergonomics: the vacuum and all its accessories can be transported in one hand.



Large, lockable cable hook, thanks to its swivel joint.



Parking position for accessories on the side of the device.



Four storage slots for accessories on the backside.



**Accessory:** Combi nozzle for textile coverings or carpets. Item-no. 111307



## TECHNICAL DATA

Voltage	220-240 V / 50 Hz
Max. power	700 W
Max. negative pressure	210 mbar*
Volume flow	38 litres / sec.
Sound pressure level	61 LpA [dB]
Container material	plastic
Container volume	13 litres (gross)
Filter bag volume	9 litres
Length of power cord	7,5 m
Length of suction hose	2,5 m
Diameter of suction tube	32 mm
Diameter of suction tube	32 mm
Weight	4,9 kg
Dimensions (L x W x H)	29 x 40 x 40,5 cm

\*Measured at the nozzle

	Item-no.	UK	EU
<b>MAXIMUS PT</b>	111071		111018

1 x aluminium tube 2 x 0,5 m, ø 32 mm, suction hose 2,5 m, fleece filter basket, 1x HEPA13 fleece filter bag, crevice nozzle, furniture nozzle, hard floor nozzle 360 mm, power tool adaptor, power cord 7,5 m, black

## STANDARD KIT:

Aluminium tube, 0,5 m (1 piece)	106026
Suction hose complete, 2,5 m	106025
Hard floor nozzle 360 mm	111202
Crevice nozzle 230 mm	101023
Furniture nozzle	101024
Power tool adaptor	101025
Fleece filter basket	111125
Power cord 10 m, black	111192 111155

## ACCESSORIES:

Fleece filter bags (10 pieces)	106013
Fleece filter bags (250 pieces)	106014
HEPA13 fleece filter bags (10 pieces)	106061
HEPA13 filter cartridge	111132
HEPA14 filter cartridge <b>Tip</b>	111193
Telescopic tube, stainless steel, 0,6 - 1,0 m	117228
Vacuum hose, 3 m, antistatic	109111
Handle, antistatic with connection sleeve	117148

ACCESSORIES OVERVIEW, see page 46,47 and 106.





Available with  
**15m  
power cord**  
or  
**36V  
Li-ion  
power**

# BOOSTIX

Backpack vacuum cleaner.

Available with power cord or wireless with a 36 V lithium ion technology.

Ideal for cleaning staircases, public transport vehicles or large halls fitted with seating, e.g. cinemas and theatres. The low weight in combination with a high level of carrying comfort makes long working intervals possible. The fully padded and ergonomic carrying system with standard chest strap may be individually adapted to each user. The well-designed carrying system ensures a pleasant clearance between your back and the backpack vacuum cleaner. The air can circulate, and heat build-up is avoided.

## BOOSTIX iGO



High efficiency and extra long motor life due to brushless EC motor.



Two series-connected 18 V batteries guarantee **up to 42 minutes** of running time. The fast charger ensures a battery charging time of just under an hour.



Optional: 7.5 Ah with a battery life of **up to 60 minutes**.  
Art. no. 119122

Premium-quality and comfortable carrying system for both BoostiX models.

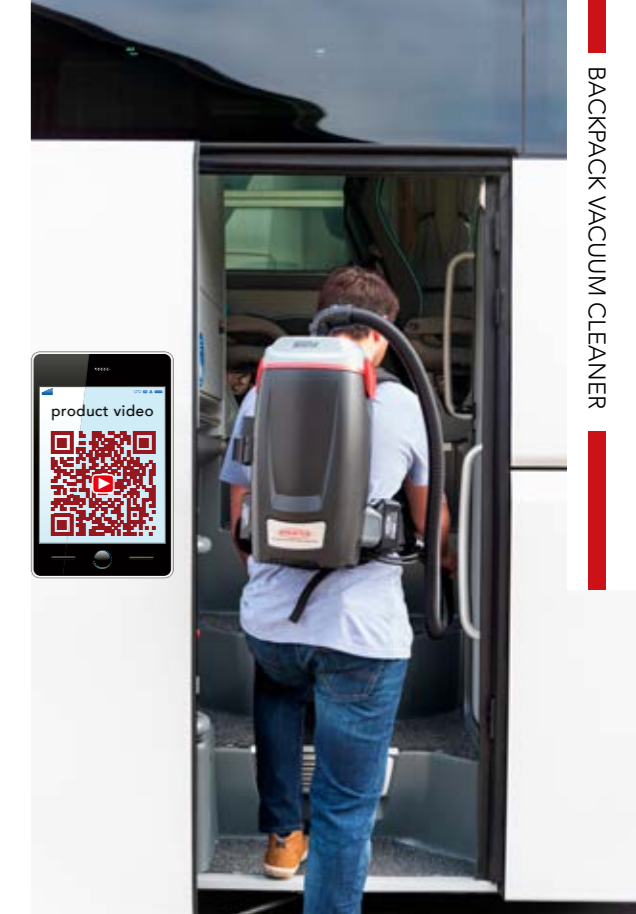

Perfect for narrow entrances, staircases and rooms.





Basic equipment:

**BOOSTIX with power cord**



Power cord, 15 m pluggable.



Pluggable power cord and integrated cable fuse.



Easy-to-reach power button.

**BOOSTIX iGO 36 V**

Charge level indicator on the battery.



Optionally with 5 Ah or 7.5 Ah batteries



Fast charger.  
Item-no. 119120



ECO mode with the battery version.



- ① HEPA13 5 litre fleece filter bag Item-no. 119102
- ② HEPA13 filter basket Item-no. 119103



360° swivel joint, limitless manoeuvrability.



Convenient accessories storage.

**BOOSTIX UND BOOSTIX iGO**



2-in-1 crevice-/upholstery nozzle.  
Item-no. 115127



Telescopic tube stainless steel 0,6 –1,0 m.  
Item-no. 117228



1.3 m suction hose.  
Item-no. 119124



Combi nozzle 280 mm.  
Item-no. 114114

Optional:



Flat floor nozzle 280 mm.  
Item-no. 119126

- ① Transport position
- ② Parking hook



Item-no. UK EU

<b>BOOSTIX</b>	119004	119001
Telescopic tube, Ø 32 mm stainless steel, suction hose 1,3 m, HEPA13 filter basket, HEPA13 Fleece filter bag, 2-in-1 crevice-/upholstery nozzle, combi nozzle 280 mm, parking hook, power cord, 15 m pluggable, signal red		
power cord, 15 m pluggable, signal red	119127	119119

<b>BOOSTIX iGO</b>	Item-no. 119008	
--------------------	-----------------	--

Without batteries and charger incl. telescopic tube, Ø 32 mm stainless steel, suction hose 1,3 m, HEPA13 filter basket, HEPA13 Fleece filter bag, 2-in-1 crevice-/upholstery nozzle, combi nozzle 280 mm, parking hook

<b>BOOSTIX iGO 5 Ah</b>	Item-no. 119002	
-------------------------	-----------------	--

Standard equipment as 119008 additionally 2 x lithium-ion battery 5 Ah and 1 x quick charger

<b>BOOSTIX iGO 7,5 Ah</b>	Item-no. 119009	
---------------------------	-----------------	--

Standard equipment as 119008 additionally 2 x lithium-ion battery 7,5 Ah and 1 x quick charger

<b>STANDARD ACCESSORIES: BOOSTIX / BOOSTIX 36 V:</b>		
Telescopic tube, Ø 32 mm stainless steel	117228	
suction hose, 1,3 m	119124	
HEPA13 filter basket	119103	
combi nozzle 280 mm	114114	
2-in-1 crevice-/upholstery nozzle	115127	
Parking hook	119118	

<b>OPTIONAL ACCESSORIES:</b>		
HEPA13 Fleece filter bag (10 pcs.)	119102	
Handle, antistatic	117148	
Quick charger	119120	
Li-ion battery pack 18 V, 5 Ah	119121	
Li-ion battery pack 18 V 7,5 Ah	119122	

ACCESSORIES OVERVIEW, see page 46,47 and 106.

Technical Data	BOOSTIX	BOOSTIX iGO
Voltage	220-240 V / 50Hz	36V
Max. power	890 W	300 W
Sound pressure level	71 LpA [dB]	67 LpA [dB]
Max. negative pressure	244 mbar*	160 mbar*
Volume flow	56,8 Litres / sec.	29 Litres / sec.
Container material	plastic	
Container volume	6 litres (gross)	
Filter bag volume	5 litres	
Length of power cord	15 m	—
Li-ion battery	—	2x 18 V, 5 Ah
Length of suction hose	1,3 m	
Diameter of suction hose	32 mm	
Diameter of suction tube	32 mm	
Weight	5,4 kg	6,6 kg
Dimensions (L x B x H)	49,6 x 26 x 21,6 cm	





# Accessories dry vacuum cleaners



**TIP** The rotating brush roller thoroughly removes tenacious animal hair from sofas, car seats and other upholstered furniture.



Turbo upholstery brush.  
Item-no. 111190  
Easy to open and to clean.



**2in1** upholstery nozzle.  
Item-no. 117294

With removable brush ring.



Turbo brush 284 mm.  
Item-no. 106012

**TIP** Ideal for deep cleaning of all textile coverings such as dirt-absorbing mats.



**TIP** Ideal for hard-to-reach areas such as radiators or between car seats.

Flexible crevice nozzle 600 mm.  
Item-no. 111203



Flat floor nozzle 280 mm.  
Item-no. 119126

**2in1** crevice-/ upholstery nozzle.  
Item-no. 115127



Crevice nozzle.  
Item-no. 101023

Round nozzle Ø 75 mm.  
Item-no. 101024



Combi nozzle 280 mm.  
Item-no. 114114



Combi nozzle 270 mm.  
Item-no. 106027



Combi nozzle 306 mm  
(metal bottom side).  
Item-no. 111307



Hard floor nozzle 360 mm.  
Item-no. 111202



Parquet nozzle horsehair 360 mm.  
Item-no. 111207



Plastic rail 360 mm for brush strip set 101100 and 101104.  
Item-no. 101105



Brush strip set 360 mm for hard floor nozzle 111202.  
Item-no. 101100



Horsehair strip set 360 mm for parquet nozzle 111207.  
Item-no. 101104

## Overview

Description	Ø Size	Item-no.	ARES	BOOSTIX	FLOORY	ERA EVO	ERA TEC	ERA PRO	ERA IGO
<b>Nozzles</b>									
Combi nozzle 280 mm	32 mm	114114	■	■	■	■	■	■	■
Combi nozzle 270 mm	32 mm	106027	□	□	□	□	□	□	□
Combi nozzle 306 mm	32 mm	111307	□	□	□	□	□	□	□
Parquet nozzle 360 mm horsehair with parking hook	32 mm	111207	□	□	□	□	□	□	□
Hard floor nozzle 360 mm with parking hook	32 mm	111202	□	□	□	□	□	□	□
Flat floor nozzle 280 mm	32 mm	119126	□	□	□	□	□	□	□
Turbo brush 284 mm	32 mm	106012	□	□	□	□	□	□	□
Turbo upholstery brush 160 mm	32 mm	111190	□	□	□	□	□	□	□
<b>2in1</b> upholstery nozzle 115 mm	32 mm	117294	□	□	□	■	■	■	■
Round nozzle Ø 75 mm	32 mm	101024	□	□	□	□	□	□	□
Crevice nozzle 220 mm	32 mm	101023	□	□	□	■	■	■	■
Flexible crevice nozzle 600 mm	32 mm	111203	□	□	□	□	□	□	□
<b>2in1</b> crevice-/ upholstery nozzle	32 mm	115127	■	■	□	□	□	□	□
<b>Brush strips</b>									
Horsehair strip set 360 mm for parquet nozzle 111207		101104	□	□	□	□	□	□	□
Brush strip set 360 mm for 111202		101100	□	□	□	□	□	□	□
Plastic rail 360 mm for Brush strip set 101100 und 101104		101105	□	□	□	□	□	□	□

■ standard equipment □ accessories



# MEDUSA

Industrial battery-powered sweeper for the quick, quiet and cordless cleaning of all surfaces, indoor and outdoor. The full floating main cylinder brush individually adapts to any surface, whether hard surface or carpet.

## Suggested Use

Ideal for entryways of all kinds, hallways, staircases, driveways, warehouse and office areas, airports and train stations.

The Medusa is a battery-powered machine developed specifically with professional users in mind. It has a working width of 37 cm, including its two inwards-rotating side brushes.

Objects with a diameter of up to 2 cm can be easily vacuumed during operation. With its light weight and compact dimensions, the Medusa is designed for hard-to-reach spaces. The side brushes enable a complete and thorough cleaning along edges and even in the smallest corners. The powerful Lithium-Ion battery (without memory effect) with 10.8 V and 1.5 Ah allows an operation time of approx. 45 minutes per battery. A second, optional battery can be directly stored and carried on the machine itself.

Quick-charging unit with a charging time of only 90 minutes is included with purchase.

# MADE IN GERMANY

## Features

- ▶ **Large foot pedal for activation without bending over**
- ▶ **Main cylinder brush and side brushes can be replaced without the use of tools**
- ▶ **Aluminium telescopic handle for an optimum work position**
- ▶ **Rubber wheels leave no traces, even on sensitive surfaces**
- ▶ **Enormous waste collection tray with 2 litres capacity**
- ▶ **Changeable bristled rim on the bottom of the housing**
- ▶ **Low noise volume, and therefore excellent for use during business hours**
- ▶ **Space-saving storage position**
- ▶ **Compact, light, and easy-to-handle for any user**
- ▶ **Can be carried on the cleaning trolley**



Replacement of main cylinder brush and side brushes is possible without use of tools.



Rotating cornerbrushes for perfect results in corners and edges.



Especially large waste collection tray with a volume of 2 litres.



Cordless, efficient, compact and agile.



① Standard quick charging unit. Charging time of 90 minutes per battery. Efficient regardless of batteries level at the time of charging. Fully-equipped with two batteries, the operation time lengthens to 90 minutes.

② Space-saving storage position.

③ Ergonomic handle for working without tiring.

Technical Data	
Voltage (charging unit)	220-240 V / 50 Hz
Operating voltage	10,8 V / 2 Ah
Battery duration	45 min / battery
Sound pressure level	66 LpA [dB]
Container material	plastic
Container volume	2 litres (gross)
Weight	2,8 kg
Dimensions (L x B x H)	30 x 36 x 11 cm

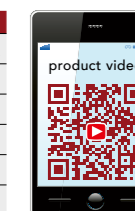

	Item-no.
<b>MEDUSA</b>	204001
1 x lithium-ion-battery, 1 x quick charging unit	
<b>MEDUSA SET WITH 2 BATTERIES</b>	204002
<b>Standard kit:</b>	
Quick charging unit without adapter	204123
Adapter for quick charging unit 204123	204124
Lithium-ion-battery (1 piece)	204101
<b>accessories:</b>	
Main cylinder brush	204119
Side brush (1 piece)	204120
Bristled rim (1 piece)	204116



# ARTOS High-quality, powerful wet / dry vacuum cleaner at a fair price.



## Suggested Use

The vacuum cleaner is perfect for cleaning buildings, industrial facilities and workshops due to its power, compact size and robust design.

The wet / dry vacuum cleaner Artos in the 30-litre class impresses thanks to its high quality and sensational value for money. Innovative features, such as the cyclone water separation system with a reliable floater system, sets the Artos clearly apart from the other wet /dry vacuum cleaner models in the entry-level class. The wide chassis and long wheelbase make the Artos a particularly agile machine, which can be manoeuvred easily over the surface to be cleaned. The 360 mm wide floor nozzle included in the

basic configuration is extremely user-friendly and can be converted from a wet floor nozzle to a dry floor nozzle by simply exchanging the rubber strips for brush strips. High-quality components, such as the strong stainless-steel container and the 1200 Watt motor, make the Artos a robust and reliable partner in professional cleaning.



TECHNICAL DATA	
Voltage	220-240 V / 50 Hz
Max. power	1200 W
Sound pressure level	72 LpA [dB]
Volume flow rate	48 litres / sec.
Max. suction	230 mbar
Container material	stainless steel
Container volume	30 litres (gross)
Length of power cord	7,5 m
Length of hose	2,5 m
Diameter of hose	32 mm
Diameter of tubes	32 mm
Weight	8,9 kg
Dimensions (L x W x H)	42 x 38 x 63 cm

Wet floor nozzle 360 mm.  
Item-no. 101087



Easy to exchange rubber strips, no tools required.  
Item-no. 101101



Always close to the action: four accessories slots and a park position for attachments on the back of the vacuum.



Easy hose click system.

The illustration shows the patented water separation system with cyclone unit.  
Item-no. 116105

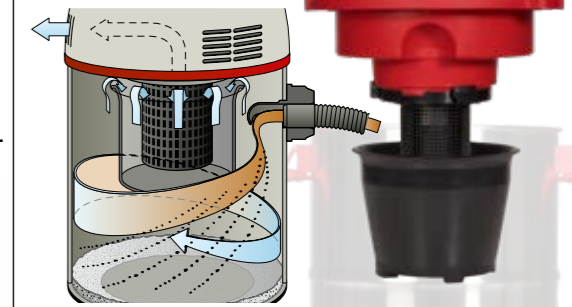

Due to the twist of the intake nozzle, the spray-fog is consequently diverted along the inner container wall. Additional filters are no longer necessary. The reliable floater system even reacts during heavy foam growth. Cooling air slots located on the side ensure the consistent separation of cooling and processed air.



Cyclone unit.  
Item-no. 116105



HEPA 13 fine dust filter cartridge.  
Item-no. 116106



The blower function is integrated on the top of the appliance and is activated simply by attaching the vacuum hose.

Item-no.	UK	EU
----------	----	----

**ARTOS** 116006 116001  
2 x 0,5 m aluminium tube ø 32 mm, 2,5 m suction hose, crevice nozzle, furniture nozzle, wet floor nozzle 360 mm, brush strip set 360 mm, HEPA 13 fine dust filter cartridge, cyclone unit, fleece filter bag, 7,5 m power cord, black

## STANDARD KIT:

Aluminium tube, 0,5 m (1 piece)		106026
2,5 m suction hose complete		114113
Wet floor nozzle 360 mm		101106
Brush strip set 360 mm		101100
Crevice nozzle		101023
Furniture nozzle		101024
Cyclone unit		116105
HEPA 13 fine dust filter cartridge		116106
7,5 m power cord, black	101107	101074

## ACCESSORIES:

Fleece filter bags (5 pieces)		101020
Telescopic tube, stainless steel, 0,6-1,0 m		117228
Spare lip 101106		101101

Accessories overview, see page 78-79 and 108-109.



# WATERKING series

Quiet and powerful wet and dry vacuum cleaners, the ideal companions for thorough cleaning. With 260 mbar suction power at 70 L/Sec, the two models **Waterking** and **Waterking XL** are extremely powerful and enable excellent area performance. Thanks to the mechanical output regulator, suction power can be adapted to any kind of flooring. With the integrated blower function, filters and work benches can be blown clean, or wet surfaces can be blown dry. On-device storage for the hose,

power cord and accessories, as well as a parking position for the tube and an ergonomic handle, ensure optimal handling and make the two devices fit for professional use. A high-performance power socket located on the head allows for the use of further cleaning machines directly through the vacuum.



## Characteristics

- ▶ Outstanding water/dirt intake
- ▶ Consistent separation of intake air and processed air
- ▶ Reliable floating gauge even reacts during heavy foam growth
- ▶ Cyclone water separation system
- ▶ Rotary joint on the vacuum hose for hindrance-free maneuvering
- ▶ Ideally suited for dry vacuuming in combination with the fine dust filter cartridge and the fleece filter bag
- ▶ Mess-free waste disposal thanks to the closeable fleece filter bag
- ▶ Robust chassis with large swivel casters and wheels



## Features



The blower function is integrated into the back side of the device and is activated by simply inserting the vacuum hose.



A powerful electrical outlet enables the use of additional cleaning tools directly through the vacuum cleaner.



Thanks to the mechanical output regulator, suction power can be adapted to any kind of flooring.

## Patented water separation system.

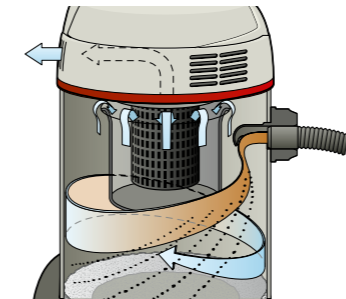

Due to the twist of the intake nozzle, the spray-fog is consequently diverted along the inner container wall. Additional filters are no longer necessary. The reliable float-er system even reacts during heavy foam growth. Cooling air slots located on the side ensure the consistent separation of cooling and processed air.



Cyclone insert for wet vacuuming.



HEPA 13 fine dust Filter cartridge for dry vacuuming.



Always close to the action: Four accessory slots and a park position for attachments on the back of the vacuum



Easy, tool-free change of rubber lips.

### WATERKING

- ▶ 30 liters container volume
- ▶ 360 mm wide floor nozzles



### WATERKING XL

- ▶ 45 liters container volume
- ▶ 450 mm wide floor nozzles
- ▶ Innovative locking brake on the sturdy chassis
- ▶ Large, easy-to-remove push bar
- ▶ Drain hose for comfortably emptying the container
- ▶ Rubber-coated swivel casters and back wheels
- ▶ High volume flow rate thanks to 38 mm hose and tube diameter



## Additional equipment for WATERKING XL



Wastewater drain hose for easy emptying of the container.



The locking brake can be operated from either side and prevents the vacuum cleaner from rolling away.



Sturdy chassis of impact-resistant plastic.

Large rubber-coated swivel casters Ø 100 mm and back wheels Ø 180 mm.

Tool free removable push bar.



Item-no. UK EU

### WATERKING

109500 109001

2 x 0,5 m suction tubes stainless steel ø 38 mm, 2,5 m suction hose, crevice nozzle and furniture nozzle, dry floor nozzle 360 mm, wet floor nozzle 360 mm HEPA13 fine dust filter cartridge, fleece filter bag, cyclone unit, 7,5 m power cord, black

Item-no. UK EU

### WATERKING XL

109902 109900

2 x 0,5 m suction tubes stainless steel ø 38 mm, 3 m suction hose, crevice nozzle and furniture nozzle, wet floor nozzle 450 mm, dry floor nozzle 450 mm, HEPA13 fine dust filter cartridge, fleece filter bag, cyclone unit, 10 m power cord, black

## Accessories



Extremely robust metal floor nozzle, 450 mm. Item-no. 102051



Antistatic suction hose, 3 m. Waterking Item-no. 109112 Waterking XL Item-no. 118193



Fleece filter bag. Waterking Item-no. 101020 Waterking XL Item-no. 102031



Rubber lips. 360 mm Item-no. 109074 450 mm Item-no. 101026

TECHNICAL DATA	Waterking	Waterking XL
Voltage	220-240 V / 50 Hz	
Max. power	1300 W	
Number of turbines	max. 1500 W	
Sound pressure level	68 LpA [dB]	70 LpA [dB]
Volume flow rate	70 litres / sec.	
Max. suction	260 mbar	
Container material	plastic	
Container volume	30 litres (gross)	45 litres (gross)
Length of power cord	7,5 m	10 m
Length of hose	2,5 m	3,0 m
Diameter of hose	32 mm	38 mm
Diameter of tubes	38 mm	
Weight	7,8 kg	13,5 kg
Dimensions (L x W x H)	46 x 38 x 59 cm	49 x 44 x 77 cm

STANDARD KIT	Waterking	Waterking XL
Vacuum tubes, stainless steel	102018	●
2,5 m suction hose complete	109069	●
3 m suction hose complete	102013	-
Wet floor nozzle 360 mm	109114	○
Wet floor nozzle 450 mm	102124	○
Dry floor nozzle 360 mm	109071	●
Dry floor nozzle 450 mm	102125	○
Crevice nozzle	102016	●
Furniture nozzle	102017	●
HEPA 13 fine dust filter cartridge	109058	●
Fleece filter bags (5 pieces)	101020	●
Fleece filter bags (5 pieces)	102031	-
Cyclone unit	109057	●
7,5 m power cord, black	109023	●
10 m power cord, black	109910	○
10 m power cord, black (UK)	109919	●

Accessories overview, see page 78-79 and 108-109.



# N series

The N series from SPRINTUS consists of three powerful wet and dry vacuum cleaners with 55-to-80-liter container volumes. They are equipped with two to three individually adjustable turbines. This makes them extremely powerful and adaptable to any application. The fine dust filter cartridge, fleece filter basket and the 450 mm extra-wide floor nozzles included in the accessories ensure an impressive area output. The sturdy chassis with metal casters and large rubbercoated wheels ensures problem-free working, even on sensitive surfaces. The robust stainless steel wet and dry vacuum cleaners **N 55/2 E** and **N 77/3 E** are used by facilities services, in maintenance and the food service industry.

They feature a convenient tilting function that allows the container to be emptied quickly and easily. Also available is an optional 650 mm gangway nozzle for wet surfaces, which can be mounted on the chassis and operated from the backside of the device.



The **N 80/2 K** is equipped with a particularly durable plastic container and is made for tough use in industry and trade. Its integrated wastewater drain hose makes it especially suitable for frequent use on wet and large surfaces.

## Features



Easy, tool-free change of rubber lips.



The fine dust cartridge, fleece filter basket and fleece filter bag guarantee an extra high filtration rate.



Larger rubber coated wheels for high comfort and silent running, even on sensitive floors.

## Characteristics

- ▶ Individually adjustable turbines
- ▶ 15 m power cord for efficient work
- ▶ Robust chassis, stable swivel casters, rubber-coated wheels
- ▶ Complete set of accessories
- ▶ Stainless steel push handle
- ▶ Extra-wide floor nozzles 450 mm



N 55/2 E

N 77/3 E

N 80/2 K



### N 55/2 E

- ▶ Two individually adjustable turbines
- ▶ 55-liter stainless steel container
- ▶ Comfortable container tilting function
- ▶ Large rubber-coated back wheels Ø 200 mm and swivel casters Ø 80 mm



### N 77/3 E

- ▶ Three individually adjustable turbines
- ▶ 77-liter stainless steel container
- ▶ Comfortable container tilting function
- ▶ Large rubber-coated back wheels Ø 240 mm and swivel casters Ø 80 mm



### N 80/2 K

- ▶ Two individually adjustable turbines
- ▶ 80-liter durable plastic container
- ▶ Wastewater drain hose for ergonomic container-emptying
- ▶ Large rubber-coated back wheels Ø 200 mm and swivel casters Ø 80 mm



## Additional equipment for N 55/2 E & N 77/3 E

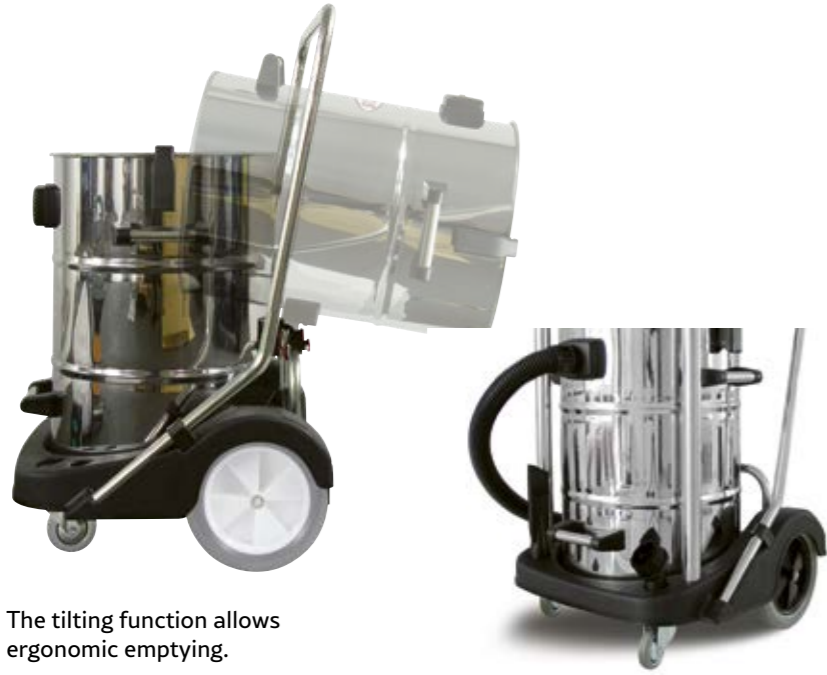

The tilting function allows ergonomic emptying.



**Optional**  
The 650 mm gangway nozzle can be easily operated with the foot pedal on the backside of the vacuum cleaner.  
N 55/2 E Item-no. 102010  
N 77/3 E Item-no. 103010

Sturdy frame with accessories slots and vacuum tube parking position.

## Additional equipment for N 80/2 K



Backsides of the device accessories are easily accessible, while stored safely.



Integrated wastewater drain hose for easy emptying of the container.



STANDARD KIT		N 55/2 E	N 77/3 E	N 80/2 K
Vacuum tubes, stainless steel	102018		●	
3 m suction hose complete	102013		●	
Suction hose complete, 15 m	102032		○	
Suction hose, antistatic and oil resistant, 3 m	118193		○	
Handle, antistatic	102061		○	
Wet floor nozzle 450 mm	102124		●	
Dry floor nozzle 450 mm	102125		●	
Crevice nozzle	102016		●	
Furniture nozzle	102017		●	
Fine dust filter cartridge	102028		●	
Fleece filter basket	102012	●	-	●
Fleece filter basket	103011	-	-	-
Fleece filter basket insert	102023	●	-	●
Fleece filter basket insert	103031	-	●	-
Fleece filter bags 35 l (5 pcs.)	102031	●	-	-
Fleece filter bags 50 l (5 pcs.)	102072	-	●	●
15 m power cord, black	103023		●	
15 m power cord, black (UK)	103040		●	

Accessories overview, see page 78-79 and 108-109.

TECHNICAL DATA	N 55/2 E	N 77/3 E	N 80/2 K
Voltage	220-240 V / 50 Hz		
Max. power	2400 W	3600 W	2400 W
Number of turbines	2	3	2
Sound pressure level	70 LpA [dB]	75 LpA [dB]	70 LpA [dB]
Volume flow rate	2 x 54 litres/sec.	3 x 54 litres/sec.	2 x 54 litres/sec.
Max. suction	210 mbar		
Container material	stainless steel	stainless steel	plastic
Container volume	55 litres (gross)	77 litres (gross)	80 litres (gross)
Length of power cord	15 m		
Length of hose	3 m		
Diameter of hose	38 mm		
Diameter of tubes	38 mm		
Weight	21 kg	27,5 kg	20,6 kg
Dimensions (LxWxH)	47 x 54 x 90 cm	59 x 62 x 95 cm	62 x 45 x 98 cm

	Item-no.	UK	EU
<b>N 55/2 E</b>		102003	102001
<b>N 77/3 E</b>		103003	103001
<b>N 80/2 K</b>		104004	104001

2 x 0,5 m suction tubes stainless steel ø 38 mm, 3 m suction hose, crevice nozzle and furniture nozzle, wet floor nozzle 450 mm, dry floor nozzle 450 mm, fine dust filter cartridge, fleece filter basket and fleece filter bag, stainless steel handles and push handle, metal swivel casters, wastewater draining hose and 15 m power cord, black, Dirty water drain hose (only N 80/2 K)

## Accessories



Extremely robust metal floor nozzle, 450 mm. Item-no. 102051

Antistatic suction hose, 3 m. Item-no. 118193



Fleece filter bags  
Item-no. 102031 35 litres  
Item-no. 102072 50 litres



Rubber lips, 450 mm. Item-no. 101026





# KETOS series

The two KETOS models are bursting with strength. These are extremely powerful, modern and commercial professional vacuum cleaners of top class and thus are made for heavy daily use of contractors, industry, maintenance service and food service. The in series connected high performance motors attain a suction power of 300 mbar at a volume flow of 70 litres/sec. per motor. They create a kind of turbo charging effect, which triggers the machine's intense power spectrum at a sound pressure level of only 69 LpA [dB] while operating at full capacity. With the **KETOS 56/2 E** and **KETOS 81/2 K**, you work sustainably and efficiently at the cutting-edge of technology and can choose between the Economy and Turbo

settings according to the demand. The reliable, patent-pending cyclone water separation system assures optimal water intake. Furthermore, the KETOS models are equipped with a blower function on the back side of the machine, which is activated simply by inserting the vacuum hose, with a robust undercarriage, metal swivel casters and rubber-coated wheels, a large lockable cable hook and an additional blower hose. The filter cartridge is easily removable. Thus, the machine's fine dust collection class can be upgraded to EPA12.



## Features



The two devices are equipped with an easily removable filter cartridge on the exhaust side, upgradable to EPA12.



Clever solution: Large, lockable cable hook, thanks to its swivel joint.



Switch on the face of the machine lets you choose between Economy and Turbo settings. Thanks to the mechanical output regulator, suction power can be adapted to any kind of flooring.

## Characteristics

- ▶ Extremely high-performance with 300 mbar suction power
- ▶ Economy and Turbo power settings
- ▶ Mechanical power regulation
- ▶ Low noise generation, only 69 LpA [dB]
- ▶ Robust chassis, stable metal swivel casters, rubber-coated wheels
- ▶ Systematically separated cool and processed air
- ▶ All accessories stored at the backside of device
- ▶ Push bar and vacuum tube made of stainless steel
- ▶ Cyclone water separation system
- ▶ Unique, lockable cable hook
- ▶ Blower function



## Patented water separation system.

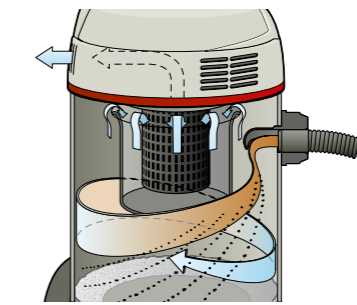

Due to the twist of the intake nozzle, the spray-fog is consequently diverted along the inner container wall. Additional filters are no longer necessary. The reliable floater system even reacts during heavy foam growth. Cooling air slots located on the side ensure the consistent separation of cooling and processed air.



Cyclone insert for wet vacuuming.



HEPA 13 filter cartridge for dry vacuuming.

### KETOS 56/2 E

- ▶ 55 liters container volume
- ▶ Solid stainless steel container
- ▶ Emptying by tipping the body or via the wastewater drain hose



### KETOS 81/2 K

- ▶ 80 liters container volume
- ▶ Wear-resistant plastic container
- ▶ Emptying via the wastewater drain hose
- ▶ Complete drainage of wastewater





Additional equipment for KETOS 56/2 E



The KETOS can either be tilted or conveniently emptied via the wastewater drain hose.



Optional for the Ketos 56/2 E  
The 650 mm gangway nozzle can be conveniently operated by foot pedal from the rear of the vacuum cleaner.  
Item no. 102010

Shown with optional metal floor nozzle.  
Item-no. 102051



Additional equipment for KETOS 81/2 K

Wastewater drain hose for a convenient and complete emptying of the container



	Item-no.	UK	EU
<b>KETOS 56/2 E</b>	112008	112001	
<b>KETOS 81/2 K</b>	112009	112002	
2 x 0,5 m suction tubes stainless steel ø 38 mm, 3 m suction hose, crevice nozzle and furniture nozzle, wet floor nozzle 450 mm, dry floor nozzle 450 mm, HEPA13 fine dust filter cartridge, fleece filter bag, cyclone unit, 10 m power cord, black			

Accessories



Extremely robust metal floor nozzle, 450 mm.  
Item-no. 102051



Antistatic suction hose, 3 m.  
Item-no. 118193



Fleece filter bags  
Item-no. 102031 35 litres  
Item-no. 102072 50 litres



Rubber lips, 450 mm.  
Item-no. 101026

TECHNICAL DATA	Ketos 56/2 E	Ketos 81/2 K
Voltage	220-240 V / 50 Hz	
Max. power	2600 W	
Number of turbines	2	
Sound pressure level	74 LpA [dB]	
Volume flow rate	2 x 70 litres / sec.	
Max. suction	300 mbar	
Container material	stainless steel	plastic
Container volume	55 litres (gross)	80 litres (gross)
Length of power cord	10 m	
Length of hose	3 m	
Diameter of hose	38 mm	
Diameter of tubes	38 mm	
Weight	21 kg	20,6 kg
Dimensions (L x W x H)	47 x 54 x 90 cm	62 x 45 x 98 cm

STANDARD KIT	Item-no.	Ketos 56	Ketos 81
Vacuum tubes, stainless steel (1 piece)	102018	●	
3 m suction hose complete	102013	●	
Wet floor nozzle 450 mm	102124	●	
Dry floor nozzle 450 mm	102125	●	
Crevice nozzle	102016	●	
Furniture nozzle	102017	●	
HEPA13 filter cartridge	109058	●	
Fleece filter bags (5 pieces)	102031	●	-
Fleece filter bags (5 pieces)	102072	-	●
Cyclone unit	109057	●	
10 m power cord, black	112135	●	
10 m power cord, black (UK)	112149	●	

Accessories overview, see page 78-79 and 108-109.



# N51/1 KPS

High-performance pump vacuum with an extremely high flow volume.



Application example:  
Flat roof sanitation

## Suggested Use

Pumping out water after floods or water main breaks, washing flat roofs, pond or pool sanitation, and other cleaning duties.

The N51/1 KPS, with its 50 litre container volume, is ideal for tough, professional use. The integrated pump with a flow volume of up to 14,000 litres per hour can be directly attached to the vacuum's power socket. A filter net prevents leaves, wood, and smaller objects from entering the container and prevents blockages.

The filter net can be conveniently emptied via the robust zipper. Wastewater is continually drained from the container through the provided 10 m wastewater hose. The C-tube connection of the wastewater hose is a standardized size that also fits fire department and technical emergency service (THW) hoses.

The N51/1 KPS can also be used in pure vacuum cleaner mode and achieves an outstanding power of 230 mbar.

## Features

- Exceptionally robust container made of impact plastic
- High-performance pump with a flow volume of up to 14,000 Litres per hour
- Separate filter net for rough particles
- 10 m wastewater hose with C-tube connection
- Also suitable for normal vacuum use

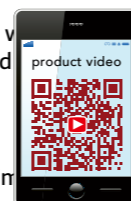

The powerful pump inside the vacuum cleaner has a capacity of up to 14,000 litres of waste water output per hour.



The 360 mm wide wet floor nozzle, pictured being used on a flat roof.



C-tube connection for 10 m wastewater hose, suitable for fire service hose.



The filter net protects the pump from leaves and other coarse particles.



High safety due to the standard circuit breaker.

## TECHNICAL DATA

Voltage	220-240 V / 50 Hz
Total power	2200 W
Power consumption (device)	1300 W
Power consumption (pump)	900 W
Sound pressure level	70LpA [dB]
Max. Suction	230 mbar
Volume flow rate	70 litres / sec.
Pump capacity	14.000 litres / h
Pumping head	9 m
Container material	plastic
Container volume	50 litres (gross)
Wastewater connection	c-tube
Length of vacuum hose	6 m
Length of discharge hose	10 m
Diameter of hose	38 mm
Diameter of tubes	38 mm
Particle size	20 mm
Length of power cord	7,5 m
Weight	15 kg
Dimensions (L x W x H)	50 x 44 x 65 cm

Item-no.	UK	EU
<b>N 51/1 KPS</b>	110500	110003

4 x 0,5 m suction tube plastic ø 38 mm, 6 m suction hose, 10 m discharge hose, integrated wastewater pump, filter net with zipper, pond nozzle, crevice nozzle, wet floor nozzle 360 mm, Power cord incl. GFCI interrupter

## STANDARD KIT:

Suction tube plastic (1 piece)	110047
Filter net	110048
7 m suction hose	110049
10 m suction hose extension	110053
Power cord incl. GFCI interrupter	110091 110072

ACCESSORIES OVERVIEW, see page 110.

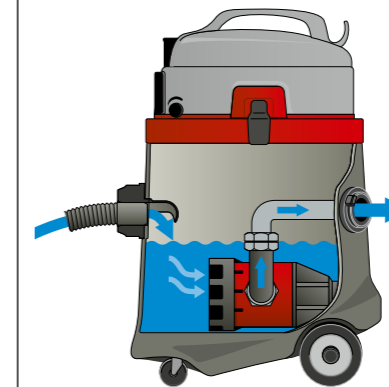

## Operating principle:

Water is pumped in through the vacuum hose.

The integrated water pump draws the collected wastewater immediately through the C-tube connection and out through the backside of the device.

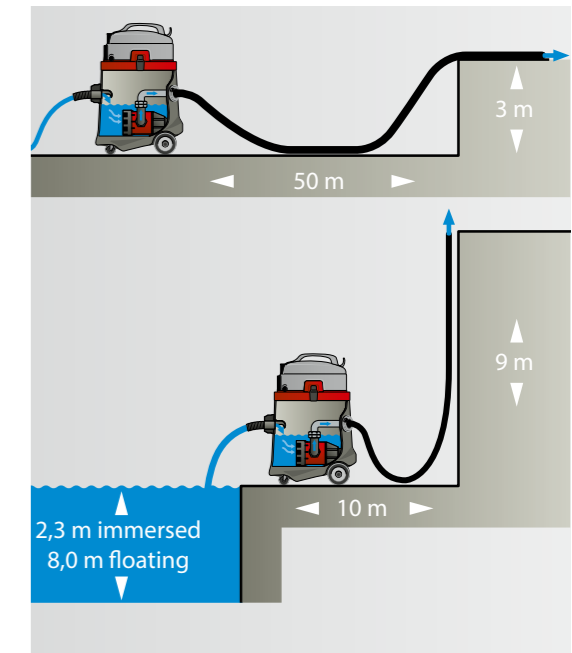

The transparent pond nozzle is also well-suited for pool cleaning and for removing water after floods.





# Heros Fire service vacuum

Powerful, compact and equipped with the latest technology.

## Suggested Use

Pumping out of water after floods, fire damage restoration, tube damage, flat roof refurbishment, pond or pool cleaning and other cleaning tasks.

This modern professional vacuum pump is specifically designed for fire brigades and federal agencies for technical relief (THW), and long-term use with all types of floods and high water. Contaminated wastewater, sludge, stones, wood and other non-flammable solids and suspended matter can be efficiently sucked away. Featuring a range of close to 20 metres, emphasis is on the highest degree of safety and performance.

The Heros comes with IP 68 connectors with bayonet retaining rings and protective covers, safety switches and an IP 54 socket as standard.

The impact-resistant and compact plastic tank allows optimum mobility with a low overall weight of only 19 kg.

Further standard fittings such as the separate connectible pump, solid rubberised wheels with practical locking brakes, and fire brigade-approved Storz coupling provides you with a reliable partner at your side.

TECHNICAL DATA	
Voltage	220-240 V / 50 Hz
Total power	2200 W
Power consumption (device)	1300 W
Power consumption (pump)	900 W
Sound pressure level	70LpA [dB]
Suction capacity	150 l/min
Max. Suction	230 mbar
Volume flow rate	70 Liter / Sek.
Pump capacity	14.000 Liter/h
Pumping head	9 m
Container material	plastic
Container volume	45 litres (gross)
Wastewater connection	c-tube
Length of vacuum hose	6 m
Length of discharge hose	10 m
Diameter of hose	38 mm
Diameter of tubes	38 mm
Particle size	20 mm
Length of power cord	10 m
Weight	19 kg
Dimensions (L x W x H)	49 x 44 x 77 cm



- ① Wastewater dump hose for complete drainage of the tank.
- ② The locking brake prevents the vacuum from accidentally rolling away.
- ③ Stable chassis of impact-resistant plastic with removable handle.



450-mm metallic base jet with extremely robust die-cast aluminium housing including adjustable castors for setting the clearance. Item.-no. 102051



	Item-no.
<b>HEROS</b>	<b>113001</b>
2 x 0,5 m suction tubes stainless steel ø 38 mm, 7 m suction hose, 10 m discharge hose, integrated wastewater pump, filter net with zipper, crevice nozzle 240 mm, Metal floor nozzle 450 mm	
<b>STANDARD KIT:</b>	
Vacuum tubes, stainless steel (1 piece)	102018
Metal floor nozzle 450 mm	102051
Crevice nozzle	102016
Filter net	110048
7 m suction hose	110049
10 m suction hose extension	110053
Power cord incl. GFCI interrupter	110072
<b>ACCESSORIES OVERVIEW, see page 110.</b>	



The powerful pump inside the vacuum cleaner has a capacity of up to 14,000 litres of wastewater output per hour.

10-metre wastewater hose with aluminium C coupling. Connection for fire brigade and THW hoses.



The filter net protects the pump from leaves and other coarse particles. Item-no. 110048



Standard crevice nozzle. Item-no. 102016

Safety as standard:

- ① IP 54 socket.
- ② IP 68 connector with bayonet retaining ring and protective cap.
- ③ FI-safety switch,
- ④ H07RN-F rubber cord





# CraftiX series

Maximum health protection in the case of hazardous dusts.

The new certified safety vacuum cleaners by SPRINTUS for dust classes L, M and H vacuum where hazardous dust is produced. Directly on the power tool. And all this with an innovative and patented automatic filter cleaning with a consistently high level of suction power.

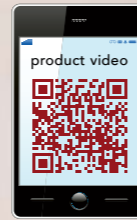

## Good reasons for efficient dust control.





Where power tools are used, dust is often produced. Not any type of dust, but harmful fine particles. The dust should be absorbed where it is formed, directly at the power tool.

This is exactly what the robust SPRINTUS safety vacuum cleaners are designed for. Whether on the construction site or in the workshop, they collect dusts that are hazardous to health at a constantly high level of suction power before it pollutes breathable air. In particular, fine dusts remain in the air we breathe in for a long time and can penetrate deep into the lung tissue. This can lead to asthma and other chronic lung diseases. For this reason, legislators also prescribe the use of certified safety vacuum cleaners at construction sites. With the CraftiX safety vacuum cleaners, you protect the user from these risks. In this way, sawing, drilling, cutting, milling and grinding work can be carried out efficiently and safely without hesitation.



## Your application is crucial.

What kind of safety vacuum cleaner is suitable for your application? The dust classes provide the answer to this question. Materials and their dusts are classified according to them and machines are certified, because the vacuum cleaners meet the corresponding requirements for dust control.

Dust class*	Maximum transmittance	Suitable for	Disposal
L 	≤ 1,0%	Dusts with OEL** values > 1mg/m <sup>3</sup> Domestic dust, soil, lime	-
M 	< 0,1%	Dusts with OEL** values ≥ 0,1mg/m <sup>3</sup> Wood, screed, primer coat and paint, plaster, cement, concrete, tile adhesive, paints such as latex and oil paints, quartz containing materials such as sand and pebbles	Low dust
H 	< 0,005%	Dusts with OEL** values < 0,1mg/m <sup>3</sup> Carcinogenic dust, dust with pathogens, dust with bacteria	Dust free
 Asbestos requirement	< 0,005%	Dusts with OEL** values < 0,1mg/m <sup>3</sup> Asbestos dust	Dust free

\*according to the standard: IEC/EN 60335-2-69 \*\*occupational exposure limit value

The table provides information about the maximum transmittance of a certified vacuum cleaner as well as the legal occupational exposure limit value of the dusts. Class-L dusts are classified as only slightly hazardous, those belonging to Class M are deemed hazardous and those belonging to Class H are regarded as extremely hazardous. No special regulations must be observed when disposing L-dusts. M-dusts, on the other hand, must be disposed of in a low dust manner and H-dusts as well as asbestos dusts must be disposed of in a dust free manner. Depending on the dust class, the use of fleece filter bags (Item-no. 102031) or special PE disposal bags (Item-no. 118138) and PE disposal bags asbestos (Item-no. 118169) for dust free disposal is recommended.



## The SPRiNTUS safety vacuum cleaners at a glance.

For an efficient control of dusts in dust class L, M and H inclusive asbestos dusts, we offer you the CraftiX model series with a total of six safety vacuum cleaners. In all dust classes, you have the choice between a model with a container volume of 35 and 50 litres.

With the CraftiX models you ensure maximum health protection of the user. The efficient filter cleaning ensures a permanently free filter with a perpetually high level of suction power. This saves you time and money because filter cleaning takes place automatically without suction current and power interruption, even in the case of extreme amounts of fine dust.



- For dusts of dust class L (page 63)
- Antistatic preparation for connecting an optional antistatic hose (Item-no. 118143) to prevent electrostatic charges
- Patented HEPA 13 cartridge filter



- For dusts of dust class L, M and H as well as asbestos dusts (page 63)
- Standard anti-static equipment for extracting large amounts of fine dust
- Patented HEPA 14 cartridge filter
- The suction power is monitored by a warning device with a acoustic and visual signal



- For dusts of dust class L and M (page 63)
- Standard anti-static equipment for extracting large amounts of fine dust
- Patented HEPA 13 cartridge filter
- The suction power is monitored by a warning device with a acoustic and visual signal





## Patented filter cleaning.

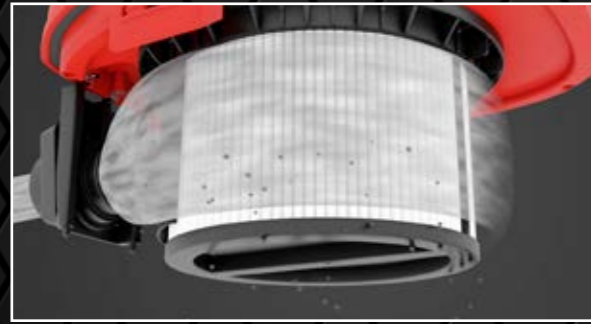

Dealing with hazardous dusts requires innovative product developments. The heart of the CraftiX is the patented HEPA 13 (dust class L, M) or HEPA 14 (dust class H) cartridge filter.

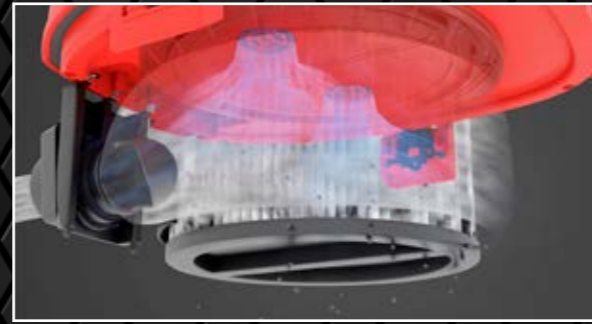

It consists of two independent filter chambers, which are cleaned one after the other. Suction current and suction power thus remain at a consistently high level even during cleaning, which guarantees permanent suction.



Filter cleaning is carried out by air backwashing and, thanks to the patented cartridge filter, ensures that the fine pores of the filter are freed from dust without leaving any residue. The maintenance and cleaning of the filter is no longer necessary and you save time and money.

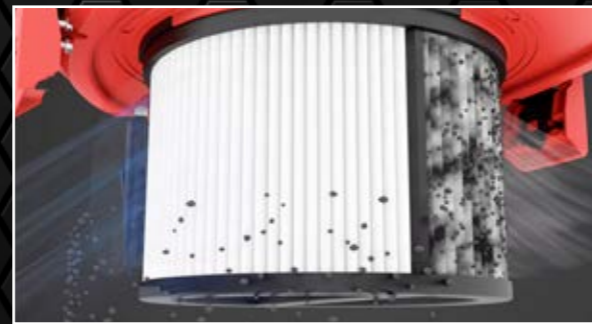

Filter cleaning takes place automatically every 45 seconds. It is quieter than average and is therefore particularly user-friendly.

## CraftiX advantages at a glance.

Whether you opt for an SPRiNTUS safety vacuum cleaner for dust class L, M or H, all six models have these innovative features.

Practical cable hooks for convenient transport.

Flat surface on the motor head with retractable carrying handle for mounting the optional adapter plate for tool cases. Item-no. 118150

Easy-to-clean blow-out filter.

Adjustable, foldable push bar for easy transport.

Integrated tool key for filter change. Item-no. 118124

Parking position for extra wide floor nozzle. Item-no. 102125

Patented filter cartridge.  
HEPA 13 (dust class L, M). Item-no. 118100  
HEPA 14 (dust class H including asbestos). Item-no. 118166



All-round elastic buffer edges.

Locking brakes prevent the vacuum cleaner from rolling away.

Maxi chassis with extra-large construction-site-compatible wheels, Ø 180 mm, and swivel castors, Ø 100 mm.

Dust-tight lockable connection nozzle for dust-free transport.

Power tool adapter for connecting power tools with suction devices of different diameters.

Ø 21 / 25 / 32 mm  
Item-no. 118122

Ø 35 mm  
Item-no. 118139

Handle for ergonomic carrying.

63,5 cm (35 litres)  
77,0 cm (50 litres)



Discover our professional **CRAFTIX** product video on



WATCH OUR FILM!

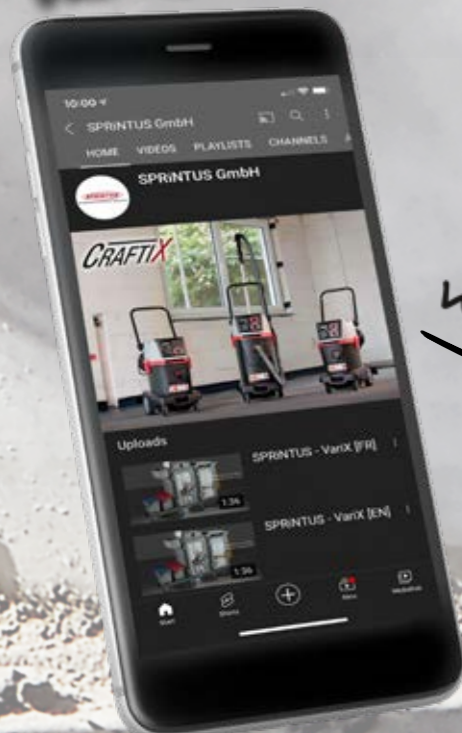



# CraftiX controls.

The suction power of the four CraftiX models of dust classes M and H is monitored by a warning device. After setting the smallest diameter used in the suction harness, the user is warned by an acoustic and visual signal if the required air flow is not reached. This avoids increased dust pollution of breathable air.

The power tool can be plugged directly into the vacuum cleaner thanks to the integrated socket. Due to the automatic switch on and off, the vacuum cleaner is started automatically or stopped with a lag of 5 seconds.



### CRAFTIX 35 M/H + 50 M/H

- 1 Selector switch hose diameter.
- 2 High safety due to warning LED and acoustic warning signal.
- 3 On/off button automatic filter cleaning.
- 4 Standard operation with infinitely adjustable power regulation.
- 5 Automatic operation with connected power tool and infinitely variable power regulation.
- 6 Socket for power tools up to a maximum of 2.200 watts.
- 7 Customisation by way of printed logo.

### CRAFTIX 35 M/L/H + 50 M/L/H

- 3 On/off button automatic filter cleaning.
- 4 Standard operation with infinitely adjustable power regulation.
- 5 Automatic operation with connected power tool and infinitely variable power regulation.
- 6 Socket for power tools up to a maximum of 2.200 watts.
- 7 Customisation by way of printed logo.

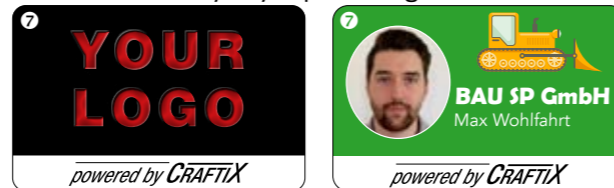

## CraftiX model comparison

Technical specifications	35 L	35 M	35 H	50 L	50 M	50 H
Voltage	220-240 V / 50-60 Hz					
Power	1200 W					
Sound pressure level	LpA 74 dB(A)					
Max. suction	250 hPa / mbar					
Volume flow rate	74 litres / sec.					
Container material	plastic					
Container volume	35 litres (gross)			50 litres (gross)		
Length power cord	10 m					
Suction hose Ø 35 mm	5 m					
Suction hose Ø 38 mm	-	2,5 m	2,5 m	-	2,5 m	2,5 m
Suction tube Ø 38 mm	✓	✓	✓	✓	✓	✓
Product weight	16 kg			19,5 kg		
Dimensions (L x W x H)	54 x 39 x 63,5 cm			54 x 39 x 77 cm		

Equipment	35 L	35 M	35 H	50 L	50 M	50 H
Vacuum tubes, stainless steel, 2 x 0,5 m	●	●	●	●	●	●
Dry floor nozzle 450 mm	●	●	●	●	●	●
Crevice nozzle	●	●	●	●	●	●
Round nozzle Ø 75 mm	●	●	●	●	●	●
HEPA 13 cartridge filter	●	●	-	●	●	-
HEPA 14 cartridge filter	○	○	●	○	○	●
Power tool adapter Ø 35 mm	●	●	●	●	●	●
Power tool adapter Ø 21, 25, 32 mm	●	●	●	●	●	●
Power tool adapter Ø 38 mm	○	○	○	○	○	○
Fleece filter bag	●	●	●	●	●	●
Disposal bag	○	●	●	○	●	●
Selector switch hose Ø	-	●	●	-	●	●
Acoustic warning signal	-	●	●	-	●	●
Warning LED	-	●	●	-	●	●
Suction hose 5 m, anti-static, oil-resistant	○	●	●	○	●	●
Suction hose 5 m	●	-	-	●	-	-
Suction hose 3 m, anti-static, oil-resistant	○	●	●	○	●	●

● standard equipment ○ accessories



Item-no. UK EU

<b>CRAFTIX 35 L</b>	118003	118001
<b>CRAFTIX 50 L</b>	118017	118015

Vacuum tubes, stainless steel 2 x 0,5 m with Ø 38 mm, suction hose 5 m with Ø 35 mm, crevice nozzle, round nozzle, dry floor nozzle 450 mm, HEPA 13 cartridge filter, fleece filter bag, rubber mains cable: H07RNF, 10 m, black, power tool adapter Ø 21 / 25 / 32 / 35 mm

Item-no. UK EU

<b>CRAFTIX 35 M</b>	118032	118030
<b>CRAFTIX 50 M</b>	118047	118045

<b>CRAFTIX 35 H</b>	118062	118060
<b>CRAFTIX 50 H</b>	118077	118075

Vacuum tubes, stainless steel 2 x 0,5 m with Ø 38 mm, anti-static and oil-resistant suction hose 5 m with Ø 35 mm, anti-static and oil-resistant suction hose 2,5 m with Ø 38 mm, crevice nozzle, round nozzle, dry floor nozzle 450 mm, fleece filter bag, power tool adapter Ø 21 / 25 / 32 / 35 mm disposal bag, rubber mains cable: H07RNF, 10 m, schwarz, HEPA 13 cartridge filter (35 / 50 M) HEPA 14 cartridge filter (35 / 50 H)

### STANDARD KIT:

Vacuum tubes, stainless steel (1 piece)	102018
Suction hose, antistatic and oil resistant, 5 m (35 + 50 M)	118143
Suction hose, antistatic and oil resistant, 3 m (35 + 50 M)	118193
Dry floor nozzle 450 mm	102125
Crevice nozzle	102016
Round nozzle	102017
HEPA 13 cartridge filter (35 / 50 M)	118100
HEPA 14 cartridge filter (35 / 50 H)	118166
Rubber mains cable: H07RNF, 10 m, black	118110
Tool key for filter change	118124
Power tool adapter Ø 21 / 25 / 32 mm	118122
Power tool adapter Ø 35 mm	118139
Power tool adapter Ø 38 mm	118141

### ACCESSORIES:

Adapter plate for tool cases	118150
Fleece filter bags 35 litres (5 pieces)	102031
Fleece filter bags 50 litres (5 pieces)	102072
Disposal bags (5 pieces)	118138
Disposal bags asbestos (5 pieces)	118169
Wet floor nozzle 450 mm	102124
Rubber strip set 450 mm	102126
Handle, antistatic	118115
set of brush strips 450mm for 102125	102127

Accessories overview, see page 78-79 and 108-109.

Fleece filter bags (5 pcs).  
Item-no. 102031



Disposal bags (5 pcs).  
Item-no. 118138



Fleece filter bags  
50 litres, (5 pcs)  
Item-no. 102072



Disposal bags  
asbestos (5 pcs).  
Item-no. 118169





Limitless customisation.



## Adapter plate for tool cases.

With only a single adapter plate from SPRINTUS you can attach tool cases of all common manufacturers to the CraftiX (Systainer, metaBOX, Tstak Box, L-Boxx, MAKPAC). The optional adapter plate can be mounted and locked on the suction head without tools and ensures safe transport of the tool boxes. Despite the mounted tool case, all operating elements and accessory slots can be used without restriction.

**Optional Adapter plate.**  
Item-no. 118150



Systainer\*



Tstak Box\*



L-Boxx\*



metaBOX\*



MAKPAC\*



\*Boxes not included



## Your advantages at a glance.

- Consistently high suction power even during automatic filter cleaning
- Patented cartridge filter with two independent filter chambers
- Very quiet automatic cleaning of both filter chambers every 45 seconds
- Large range of accessories and accessory storage directly on the device
- Just a single adapter plate for attaching all common tool cases to the CraftiX
- Unlimited customization with your personal logo sign





# Accessories wet and dry vacuum cleaners

## Nozzles Ø 32 mm



Turbo brush 284 mm.  
Item-no. 106012



Hard floor nozzle 360 mm.  
Item-no. 111202



Combi nozzle 306 mm (metal floor.)  
Item-no. 111307



Combi nozzle 280 mm.  
Item-no. 114114



Flat floor nozzle 280 mm.  
Item-no. 119126



Flexible crevice nozzle 600 mm.  
Item-no. 111203



Wet floor nozzle 360 mm.  
Item-no. 101106



Parquet nozzle horsehair 360 mm.  
Item-no. 111207



Crevice nozzle 220 mm.  
Item-no. 101023

## Nozzles Ø 38 mm



Wet floor nozzle 400 mm.  
Item-no. 102109



Wet floor nozzle 450 mm with parking hook.  
Item-no. 102124



Hard floor nozzle 450 mm with parking hook.  
Item-no. 102125



Hard floor nozzle 360 mm with parking hook.  
Item-no. 109071



Wet floor nozzle 360 mm with parking hook.  
Item-no. 109114



Combi nozzle 307 mm with parking hook.  
Item-no. 109084



Floor nozzle metal 450 mm.  
Item-no. 102051



Crevice nozzle 240 mm.  
Item-no. 102016



Gangway nozzle.  
Item-no. 102010, 103010

## Overview

Description	Ø Size	Item-no.	ARTOS	WATERKING	WATERKING XL	N 55/2 E	N 77/3 E	N 80/2 K	Ketos N 56/2 E	Ketos N 81/2 K	CRAFTIX
<b>Nozzels</b>											
Wet floor nozzle with parking hook 360 mm	32 mm	101106	■								
Hard floor nozzle parking hook 360 mm	32 mm	111202	□								
Combi nozzle 270 mm	32 mm	106027	□								
Combi nozzle 306 mm	32 mm	111307	□								
Turbo brush 284 mm	32 mm	106012	□								
Turbo upholstery brush 160 mm	32 mm	111190	□								
2-in-1 upholstery nozzle 115 mm	32 mm	117294	□								
Round nozzle Ø 75 mm	32 mm	101024	■								
Crevice nozzle 240 mm	32 mm	101023	■								
Flexible crevice nozzle 600 mm	32 mm	111203	□								
Flat floor nozzle 280 mm	32 mm	119126	□								
Wet floor nozzle 360 mm with parking hook	38 mm	109114		■	□	□	□	□	□	□	□
Hard floor nozzle 360 mm with parking hook	38 mm	109071		■	□	□	□	□	□	□	□
Wet floor nozzle 400 mm	38 mm	102109		□	□	□	□	□	□	□	□
Wet floor nozzle 450 mm with parking hook	38 mm	102124		□	■	■	■	■	■	■	□
Hard floor nozzle 450 mm with parking hook	38 mm	102125		□	■	■	■	■	■	■	■
Combi nozzle 307 mm with parking hook	38 mm	109084		□	■	□	□	□	□	□	□
Floor nozzle metal 450 mm	38 mm	102051		□	□	□	□	□	□	□	□
Round nozzle	38 mm	102017		■	■	■	■	■	■	■	■
Crevice nozzle 240 mm	38 mm	102016		■	■	■	■	■	■	■	■
Gangway nozzle 650 mm	38 mm	102010				□					
Gangway nozzle 650 mm	38 mm	103010									
<b>Brush strips and rubber lips</b>											
Brush strip set 360 mm for 111202		101100	□	□							
Spare rubber lip 360 mm for wet floor nozzle 101106, 109114 (1 piece)		101101	□	□							
Brush strip set 450 mm for 102119		102114		□	□	□	□	□	□	□	□
Rubber strip set 450 mm for wet floor nozzle 102118		102115		□	□	□	□	□	□	□	□
Brush strip set 450 mm for 102125		102127		□	□	□	□	□	□	□	□
Rubber strip set 450 mm for wet floor nozzle 102124		102126		□	□	□	□	□	□	□	□

■ standard equipment □ accessories



## Brush strips and rubber lips



Brush strip set 360 mm for hard floor nozzle 111202.  
Item-no. 101100



Horsehair strip set 360 mm for parquet nozzle 111207.  
Item-no. 101104



Brush strip set 450 mm for Hard floor nozzle 102125.  
Item-no. 102127



Rubber strip set 450 mm for Wet floor nozzle 102124.



Spare rubber lip 360 mm separately for Wet floor nozzle 101106, 109114.  
Item-no. 101101



Rubber strip set 450 mm for Wet floor nozzle 102126.



# EM17EVO

New design. New smooth-running capability. Fully equipped.

## Suggested Use

The EM 17 EVO is perfect for hard daily use with its robust planetary gear.

The 10-litre water tank ensures that work is performed quickly and comfortably. Due to the tool-free disc exchange, the EM 17 EVO can be adapted to all surfaces without long waiting times.

In combination with the Queen Bonnet Pad, unparalleled cleaning results can be achieved on carpeted floors. For optimal results in case of intense and tough dirt, the device weight can be increased with the optional 14 kg additional weight.

Due to the large rubberised wheels, the machine does not leave any marks, even on vulnerable surfaces.



## Features

- Robust planetary gearbox
- Integrated 10-litre freshwater tank
- Tool-free change of brush and disc



- new design  
- very smooth running  
- extra-large wheels



Pad holder.  
Item-no. 205122



Brush medium.  
Item-no. 205121



Brush soft.  
Item-no. 205120

## Accessories:



Power Pad.  
Item-no. 201076



Duo Pad.  
Item-no. 201077

## Accessories:



The Queen Bonnet pad for the best cleaning results on carpets and carpeted floors.  
Item-no. 201009



All operating elements are positioned on the ergonomic handle.

Large 10-litre freshwater tank.



Additional 14 kg weight.  
Item-no. 201068

## TECHNICAL DATA

Voltage	220-240 V / 50 Hz
Max. power	1200 W
Sound pressure level	57 LpA [dB]
Brush rotation	154 u/min.
Max. disk diameter	17" / 432 mm
Diameter pad holder	16-17"
Freshwater container	10 litres
Weight	41 kg
Length of power cord	12 m

	Item-no.	UK	EU
--	----------	----	----

**EM 17 EVO**  
fresh water tank, brush medium, brush soft, pad holder, 12 m power cord, signal red

## STANDARD KIT:

Brush medium 17"	205120
Brush soft 17"	205121
Pad holder (16-17")	205122
12 m power cord	201080
Fresh water tank	203100

## ACCESSORIES:

Pad white 17" (5 pieces/unit)	201005
Pad red 17" (5 pieces/unit)	201006
Pad green 17" (5 pieces/unit)	201008
Pad black 17" (5 pieces/unit)	201007
Queen Bonnet-Pad 17"	201009
Power Pad 17"	201076
Duo Pad 17"	201077
Additional weight (14 kg)	201068

ACCESSORIES OVERVIEW, see page 100-103 and 110.



# HERCULES

Powerful, extremely robust and quietly running single disc machine.



## Suggested Use

Intensive cleaning of all hard surfaces and carpeted surfaces.



The Hercules single disc machine is designed to offer an extremely silent running. It is a robust and easily operated single disc machine in the upper mid-range segment.

With its large, user-friendly and ergonomic control, the machine can easily be steered and is perfectly suited for intensive, basic and preservation cleaning. The powerful and maintenance-free steel planetary gear with 175 rpm capacity always has sufficient reserves to rapidly and thoroughly clean all hard surfaces as well as to shampoo textile surfaces. With its high entire weight of 48 kg, and the two optional 14 kg additional weights, the machine's total weight can easily be increased to 76 kg at any time as required. Ideal conditions for thorough cleaning of stubborn stains and dirt.

The Hercules offers you a durable, reliable and powerful all-rounder for flexible application on all surfaces with an outstanding price/performance ratio. The machine is equipped as standard with the full range of accessories, including a 12 litre fresh water tank, pad holder, as well as one shampooing and one scrubbing brush.

## Features

- Maintenance-free steel planetary gear
- Integrated 12 litre freshwater tank
- Tool-free changing of brushes and discs
- Robust, ergonomic handlebar

## TECHNICAL DATA

Voltage	220-240 V / 50 Hz
Max. power	1500 W
Sound pressure level	54 LpA [dB]
Brush rotation	154 u/min.
Max. disk diameter	17" / 432 mm
Diameter pad holder	16-17"
Freshwater container	12 litres
Weight	48 kg
Length of power cord	12 m
Additional weight	14 kg



Ergonomic, robust, handle with integrated cable protection.



Mechanism completely made of metal. Parts that come into contact with water are made of brass.



High quality, robust and play-free drawbar for optimal handling.



Brush medium.  
Item-no. 205121



Brush soft.  
Item-no. 205120



Pad holder.  
Item-no. 205122



**Accessories:**  
Pads for any surface in several degrees of hardness.



Power Pad.  
Item-no. 201076



Duo Pad.  
Item-no. 201077

	Item-no.	UK	EU
<b>HERCULES</b> fresh water tank 12 litres, brush medium, brush soft, pad holder, 12 m power cord, signal red	205005		205001
<b>HERCULES "Heavy duty"</b> with full equipment incl. 1 x Additional weight 14 kg. The over all weight of the machine is 62 kg.	205006		205002
<b>STANDARD KIT:</b>			
Brush medium 17"			205121
Brush soft 17"			205120
Pad holder (16-17")			205122
Fresh water tank			205105
12 m power cord, signal red	201080		201030
<b>ACCESSORIES:</b>			
Pad white 17" (5 pieces/unit)			201005
Pad red 17" (5 pieces/unit)			201006
Pad green 17" (5 pieces/unit)			201008
Pad black 17" (5 pieces/unit)			201007
Queen Bonnet-Pad 17"			201009
Power Pad 17"			201076
Duo Pad 17"			201077
Additional weight (14 kg)			205123
<b>ACCESSORIES OVERVIEW, see page 100-103 and 110.</b>			



# HERCULES Duo Speed

Robust single disc machine with two working speeds (180 / 360 revolutions / min.) for efficient, fast and cost-effective cleaning and polishing.

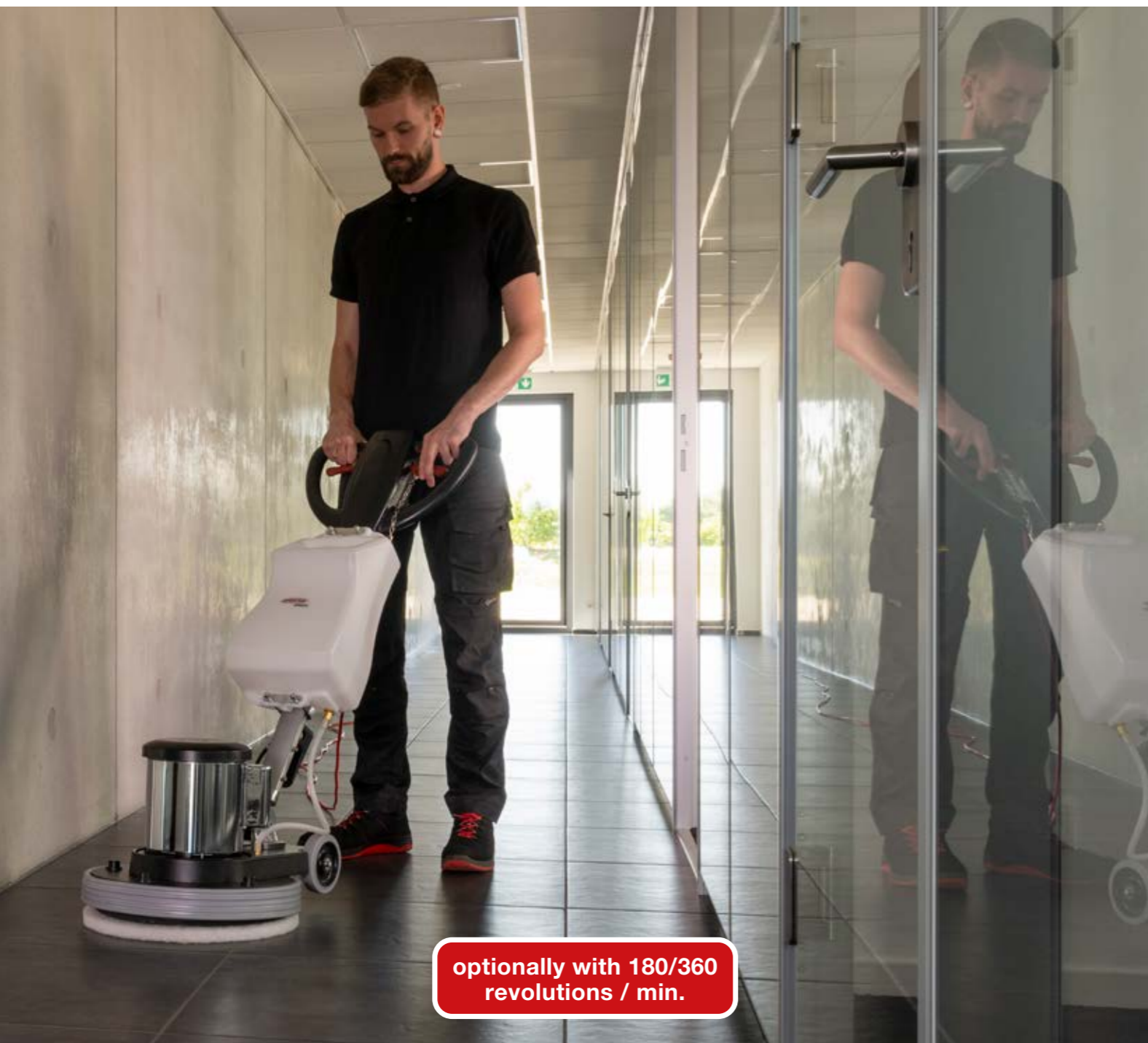

optionally with 180/360 revolutions / min.

### Two in one

The Hercules Duo Speed combines the advantages of a slow and fast runner in only one device. Owing to its two working speeds, it is the perfect solution for efficient, fast and cost-effective cleaning and polishing.

As low-speed machine operated with 180 rpm, our new Hercules Duo Speed is ideal for basic cleaning of a wide variety of floor coverings. When changing the working speed to 360rpm, our robust single-disc machine also enables the crystallization of natural stone floors as well as polishing of various floor coverings. The two working

speeds can be easily switched with the integrated button on the motor head.

The Hercules Duo Speed is not only extremely versatile but also provides the same advantages and features of our well-established and high-quality Hercules single disc machine. The large, user-friendly and ergonomic control element makes the Hercules Duo Speed easy to operate.

The Hercules Duo Speed fulfils all conditions in order to clean heavily dirty surfaced. In addition by choosing the Hercules Duo Speed, you do not only benefit from an excellent price-performance ratio but also from a long-lasting, reliable and powerful single disc machine, flexibly applicable on all surfaces. The machine is supplied with standard equipment including a 12 liter fresh water tank, a pad driving plate, and a shampooing and scrubbing brush.

### TECHNICAL DATA

Mains voltage	220-240 V / 50 Hz
Power	1500 W / 1000 W
Sound pressure level	54 LpA [dB]
Brush speed	180 / 360 rpm
Max. pulley diameter	17" / 432 mm
Diameter of driving disc	16-17"
Fresh water tank	12 liters
Weight	48 kg
Cable length	12 m

	Item no.
<b>HERCULES DUO SPEED</b>	208001
incl. fresh water tank 12 liters, scrubbing brush, shampooing brush, pad driving plate, power cord 12 m, signal red	
<b>STANDARD ACCESSORIES:</b>	
Scrubbing brush 17"	205121
Shampooing brush 17"	205120
Pad driving plate (16-17")	205122
Fresh water tank	205105
Power cord 12 m	201030
<b>OPTIONAL ACCESSORIES:</b>	
Pad white 17" (PU 5 pcs.)	201005
Pad red 17" (VE 5 pcs.)	201006
Pad green 17" (PU 5 pcs.)	201008
Pad black 17" (PU 5 pcs.)	201007

ACCESSORIES OVERVIEW, see page 100-103 and 110.



Ergonomic, solid handle element with robust switches and integrated bend protection for the power cord.



Complete mechanics made of metal. Parts that come into contact with water are made of brass.



High quality and robust draw bar for optimal handling.



Switch to change operating speeds.  
L = 180 revolutions / min.  
H = 360 revolutions / min.



Scrub brush.  
Art.-Nr. 205121



Shampoo brush.  
Art.-Nr. 205120



Pad driving plate.  
Art.-Nr. 205122



Disc pads for any surface in various degrees of hardness.





# ZEUS

The new ZEUS single disc floor cleaner is a masterpiece of ergonomics and innovation for the challenging, professional cleaning of hard surfaces and textile floor coverings.



Duo Pad.  
Item-no. 201077

Power Pad.  
Item-no. 201076

Uniquely, the 10 litres fresh water tank sits directly on the machine and therefore ensures an optimum contact pressure, easy handling and perfect cleaning results. The user can remove the tank in just a single action, and work efficiently beneath objects or in edge zones thanks to the low ground clearance of just 10 cm.



The standard convenient advantage: The fresh water tank, equipped with a stretch hose, can be simply topped up with water directly at the tap.

With its racy and powerful 1,500 Watt motor and the maintenance-free steel planetary gearing with 175 rpm, the ZEUS is extremely powerful and yet incredibly quiet. It is easy to operate and also enables inexperienced users to work safely, in an energy-efficient and fatigue-free manner. Added to this, it is simple to transport and space-saving when stored, because the shaft can simply be folded down fully.

If necessary, the Zeus can be flexibly upgraded from a 54 kg net weight to a maximum 64 kg. Thanks to the special latching element, brushes and discs can be switched in seconds without tools.

The new Zeus offers the maximum in quality, reliability and durability, and frequently proves to be a smart solution provider in everyday work.



with 12 m  
signal red  
power cord



Upright parking position for space-saving storage and brush pretection.



Freshwater tank can directly be filled at the sink with stretch hose.



Large, rubbered wheels which are offset to the rear for easy and quiet transport.



Brush medium. Item-no. 205121  
Brush soft. Item-no. 205120  
Pad holder. Item-no. 205122



10 litre freshwater tank can be removed in one easy movement.

TECHNICAL DATA	
Voltage	220-240 V / 50 Hz
Max. power	1500 W
Sound pressure level	54 LpA [dB]
Brush redation	154 u/min.
Max. disk diameter	17" / 432 mm
Diameter pad holder	16-17"
Freshwater container	10 litres
Weight	54 kg
Length of power cord	12 m

	Item-no.	UK	EU
<b>ZEUS</b>			
10 litre fresh water tank, brush medium, brush soft, pad holder, 12 m power cord	206003		206001
<b>STANDARD KIT:</b>			
Brush medium 17"			205121
Brush soft 17"			205120
Pad holder (16-17")			205122
12 m power cord	201080		201030
Fresh water tank			206113

ACCESSORIES:		
Pad white 17" (5 pieces/unit)		201005
Pad red 17" (5 pieces/unit)		201006
Pad green 17" (5 pieces/unit)		201008
Pad black 17" (5 pieces/unit)		201007
Queen Bonnet-Pad 17"		201009
Power Pad 17"		201076
Duo Pad 17"		201077

ACCESSORIES OVERVIEW, see page 100-103 and 110.



# EEM13 R Orbital single disc machine.



**TIP** EEM 13 R Set with pump tank.  
Item-no. 202005



**Accessories:**  
Pump tank  
Item-no. 202037

### Suggested Use

Bathrooms, baths, changing rooms, stairs, hard surfaces and carpeting.

The EEM 13 R orbital single disc machine is ideal for cleaning small surfaces, niches and corners due to its compact construction and simple operation.

With its nominal weight of 12.7 kg, it is also suited for use on staircases. The eccentric transmission ensures effective cleaning and problem-free, safe maneuvering without effort or strain. The large rubber-coated wheels allow for convenient transport without leaving traces on the freshly-cleaned surface.

You can clean hard surfaces, buff stone and parquet flooring, and even shampoo carpeting with the included accessories.

### Features

- Powerful eccentric transmission
- Compact design for easy handling
- Safe maneuvering without effort
- Complete accessories for all types of flooring

### TECHNICAL DATA

Voltage	220-240 V / 50 Hz
Max. Power	250 W
Sound pressure level	62 LpA [dB]
Brush rotation	150 U/Min.
Brush/ pad disk size	10" / 254 mm
Max. disk diameter	13"
Weight	12,7 kg
Length of power cord	7,5 m



Extremely quiet and easy to operate, suitable even for unexperienced users.



Pad holder.  
Item-no. 202010



Brush medium.  
Item-no. 202011



Brush soft.  
Item-no. 202012

### Accessories:



Queen Bonnet Pad. Item-no. 202034  
The Queen Bonnet Pad for the best cleaning results on carpets and carpeted floors.



7,5 m with signal red power cord

The compact EEM 13 R is perfectly suited for staircase cleaning. Small and compact, also great for all difficult to reach places and corners.

### Accessory:

Power Pad.  
Item-no. 202039  
For extra high cleaning performance on all floor coverings.



Item-no. UK EU

**EEM 13 R** 202009 202001  
brush medium, brush soft, pad holder, 7,5 m power cord

**EEM 13 R Set with pump tank** 202500 202005  
brush medium, brush soft, pad holder, 7,5 m power cord, signal red

### STANDARD KIT:

Brush medium (280 mm)	202011
Brush soft (280 mm)	202012
Pad holder (254 mm)	202010
7,5 m power cord, signal red	202043 202038

### ACCESSORIES:

Pad white 13" (5 pieces/unit)	202033
Pad red 13" (5 pieces/unit)	202035
Pad green 13" (5 pieces/unit)	202032
Pad black 13" (5 pieces/unit)	202036
Queen Bonnet Pad 13" (330 mm)	202034
Power Pad 13"	202039
Attachment set for pump tank for EEM 13 R	202037

ACCESSORIES OVERVIEW, SEE PAGE 100-103 AND 110.



# TITAN

High-performance orbital machine with excellent cleaning results and safe operation.



with 12 m signal red power cord

The orbital technology combines two types of motion to achieve a higher mechanical cleaning effect while reducing the use of chemistry and protecting the environment. The interplay of eccentric and rotating movements generates a special efficient cleaning pattern and thus differs from classic single-disc machines, which perform a pure rotational movement. In terms of smooth running, the orbital method also has a very positive effect on handling and makes it possible to drive

the machine in a safe and fatigue-free manner at all times. Even inexperienced users can quickly become familiar with the Titan and achieve excellent work results in the shortest possible time. The areas of application in basic and maintenance cleaning, polishing, and scrubbing on all floor coverings (carpet, stone, PVC, wood, safety tiles) are almost limitless.



Advantages of the orbital machine in comparison to a single-disc machine.

- less water
- less chemicals
- less time
- less effort
- contact surface area 100 % (see right)

Thanks to significantly higher mechanical cleaning effect!

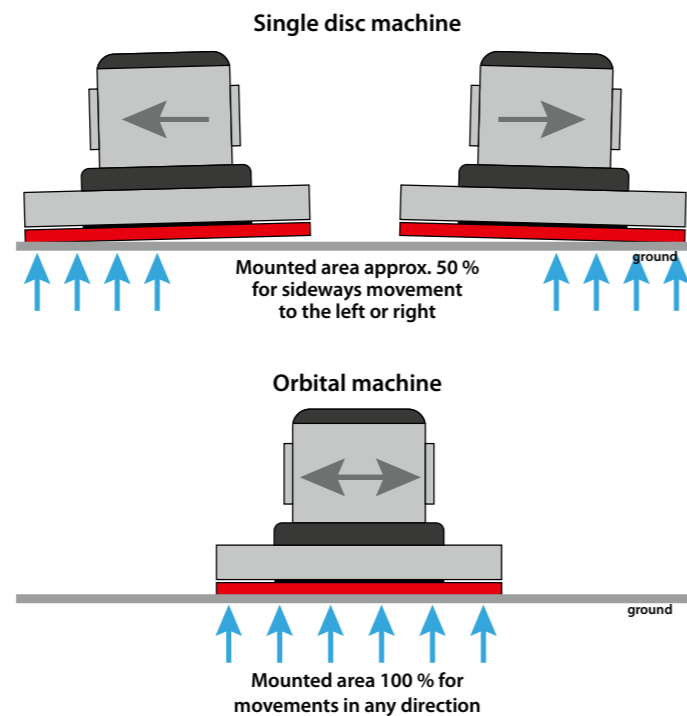

Tilting drawbar for increasing the contact pressure.



Motor protection cover protects the motor from moisture.



Excellent stairway mobility and stability.



Optional additional weight, 12 kg. Item-no. 207119



Pad holder. Item-no. 207113



Power Pad for all surfaces. Item-no. 201076

Accessories:



Brush medium. Item-no. 207115

Disc pads for each surface in different degrees of hardness.



	Item-no.	UK	EU
<b>TITAN</b> fresh water tank 12 litres, power pad 17", pad holder, 12 m power cord, signal red	207005		207001
<b>TITAN "Heavy duty"</b> with full equipment incl. 1 x Additional weight 12 Kg. The over all weight of the machine is 58 Kg.	207006		207003
<b>STANDARD KIT:</b>			
Pad holder (16-17")			207113
Fresh water tank			207102
Power Pad 17"			201076
12 m power cord, signal red	201080		201030
<b>ACCESSORIES:</b>			
Pad white 17" (5 pieces/unit)			201005
Pad red 17" (5 pieces/unit)			201006
Pad green 17" (5 pieces/unit)			201008
Pad black 17" (5 pieces/unit)			201007
Queen Bonnet Pad 17"			201009
Brush medium			207115
Additional weight (12 kg) incl. screws			207119
<b>ACCESSORIES OVERVIEW, SEE PAGE 100-103 AND 110.</b>			

<b>TECHNICAL DATA</b>	
Voltage	220-240 V / 50 Hz
Max. power	1100 W
Sound pressure level	56 LpA [dB]
Brush redation	1490 u/min.
Max. disk diametre	17" / 432 mm
Diameter pad holder	16-17"
Freshwater container	12 litres
Weight	46 kg
Length of power cord	12 m
Additional weight	12 kg





# TORANA

Battery powered 24 V floor scrubber dryer. Easy handling due to compact dimensions. Ideal for small and highly obstructed areas. Thanks to a brilliant aspiration system, places open to the public can also be cleaned during opening hours.



Battery operation: Battery life, 75 min. under normal operation, 120 min. in ECO mode. For small to medium-sized areas. Area efficiency, approx. 1,260 m<sup>2</sup>/h. Excellent aspiration system. The floor is fully dried and can be walked on right away.



**Suitability**  
Ideal for office buildings, the retail sector, catering, hotels, schools, nursing homes, showrooms, hospitals and fitness centers.

### Features

- Beltless direct drive
- Suction bar automatically turns into the direction of workflow
- Swinging suspended brush adapts to any surface
- Evenly high brush pressure - 15 kg
- Battery operation: Battery life, approx. 75 min. under normal operation, and 120 min in ECO mode
- Pleasant, quiet running allows cleaning even during opening hours
- Area efficiency, approx. 1,260 m<sup>2</sup>/h
- Standard charge level indicator and integrated charger
- Two maintenance-free 33 Ah gel batteries

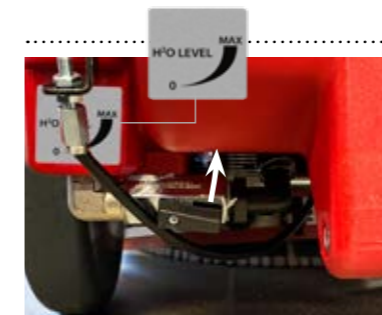

The water quantity can be adjusted for any floor covering.



Long lasting ball-bearing wheels.



Practical fresh water indicator.



Hygienic and easy-to-clean waste water tank.



Comfortable brush ejection at the push of a button.



The machine can be easily transported via the support wheel.



Rubberised guard roller allows for cleaning that is damage-free and close to floor edges.



The manoeuvrability of the TORANA makes it possible to use it in the very smallest of spaces. Ideal for highly obstructed areas.





Removable, easy-to-clean 16-litre waste water tank.

Easy filling of the fresh water tank.

15-litre clean water tank.

Direct drive.

Swinging suspended brush, adapts automatically to any surface and compensates for slightly uneven surfaces.



**Clearly arranged operation panel.**  
All operating elements and switches are located on the panel and the ergonomically shaped handle. This ensures handy machine operation even in the smallest of spaces.

Large, rubber wheels.

Suction bar automatically turns into the direction of workflow.



Internal charger with charge level indicator.

- ① The operating height of the control unit can be ergonomically adjusted.
- ② Lift/drain the suction bar.
- ③ Fresh water fill level indicator.



The maintenance-free gel batteries can be removed without tools via quick-connect couplings.



The clean water tank can be fully drained.



The dirty water tank can be emptied via the drain hose.



Easy filling of the 15-litre clean water tank.

**Scrubbing brushes:**  
Brushes with different degrees of hardness are available for different surfaces.



Brush soft 15" Item-no. 210429  
 Brush medium 15" (Standard) Item-no. 210427  
 Brush abrasive 15" Item-no. 210428  
 Brush horsehair 15" Item-no. 210430

**Tip**  
The horsehair brush is ideal for stoneware and safety tiles.

**Optional:**



Pad holders and pads with different degrees of hardness.  
 Duo Pad. Item-no. 210243



TORANA		Item-no.	UK	EU
<b>TECHNICAL DATA</b>				
Voltage (charging unit)	220-240 V / 50 Hz		210044	210040
Operating voltage	24 V / 2 x 33 Ah			
Max. suction (water)	83 mbar			
Max. power vacuum	270 W			
Max. power brush	400 W			
Sound pressure level	71 LpA [dB]			
Area output	1260 m <sup>2</sup> /h			
Brush redaction	130 U/min			
Brush contact pressure	15 kg			
Brush width	36 cm			
Working width suction bar	46 cm			
Freshwater tank	15 litres			
Wastewater tank	16 litres			
Weight	46 kg			
Dimensions (H x L x W)	98 x 47 x 99 cm			
<b>TORANA K</b> (deviating from TORANA)				
<b>TECHNICAL DATA</b>				
Max. suction	89 mbar			
Max. power vacuum	350 W			
Max. power brush	300 W			
Weight	57 kg			
<b>TORANA</b>				
Brush medium, integrated onboard charger			210044	210040
Charging cable 1 m, red			210133	210132
<b>TORANA K</b>			210045	210041
Brush medium, cable version without battery				
<b>STANDARD KIT:</b>				
Brush medium 15"				210427
2 x 12 V gel-battery à 33 Ah (individual)				210431
<b>ACCESSORIES:</b>				
Brush soft 15"				210429
Brush abrasiv 15"				210428
Brush horsehair 15"				210430
Pad white 15" (5 pieces/unit)				210122
Pad red 15" (5 pieces/unit)				210131
Pad green 15" (5 pieces/unit)				210124
Pad black 15" (5 pieces/unit)				210123
Duo Pad 15"				210243
Pad holder with pad lock				210426
<b>ACCESSORIES OVERVIEW, see page 100-103 and 111.</b>				



# CAMIRA

Battery operated, 24 V scrubber dryer.  
Easy handling due to compact size.

The CAMIRA is the latest product highlight of the SPRINTUS scrubber dryers. The machine, which is part of the 30-litre-class, convinces with a compact design and agility, which allows for extremely easy and efficient cleaning.

Equipped with two maintenance-free Sonnenschein gelbatteries with 50 Ah each, the running time is about 120 minutes and the machine cleans quickly and effectively medium-sized areas of up to 1600 m<sup>2</sup>. At a low battery level, the connectible ECO mode can be activated and extends the running time of the machine when needed to conclude the cleaning task. The swiveling suction bar ensures an excellent suction power even during change of directions and the standard brush with a working width of 43 cm is perfect for a variety of cleaning tasks. The voluminous waste water tank, which can easily be cleaned due to its accessibility, is equipped with a user-friendly drain hose. The clean water tank can also be drained completely and makes the CAMIRA with its "brushdrop" at the push of a button, a standard on-board charger, and its excellent price-performance-ratio one of the most user-friendly machines in its class.



The CAMIRA is perfectly suited for medium sized areas of up to 1600 m<sup>2</sup>.

Battery runtime of up to 120 minutes.

The standard eco-mode guarantees a longer battery runtime and greater coverage. To start the eco-mode, push the SMART RUN button for two seconds until the display starts to blink.

User-friendly, ergonomic operating device with all functions clearly displayed.

With the SMART RUN button, you can easily activate all functions. Brush redaction, suction and water supply.



Suction and water supply can be turned on and off individually.

On-/off button.

Battery runtime display.



Suction bar swivels automatically into the working direction.



Rubber castors ensure a safe cleaning performance along edges.



Standard waste water drain hose.



① Working height can be adjusted individually.

② Lift and release squeegee.



The extremely narrow construction design guarantees a perfect handling and unique maneuverability.





Clean water can be drained completely and comfortably with the fast closure system.



Water amounts can be adjusted individually to floor type.



Large, easy to clean waste water tank.



Internal charging station with battery runtime display.



Due to the support wheel, the machine can be transported easily.

**CAMIRA**

**TECHNICAL DATA**

Voltage (charging unit)	220-240 V / 50 Hz
Operating voltage	24 V / 2 x 50 Ah
Max. suction (water)	65 mbar
Max. power vacuum	400 W
Max. power brush	400 W
Sound pressure level	71 LpA [dB]
Area output	1600 m <sup>2</sup> /h
Brush rotation	150 U/min
Brush contact pressure	18 kg
Brush width	43 cm
Working width suction bar	54 cm
Freshwater tank	32 litres
Wastewater tank	35 litres
Weight	95 kg
Dimensions (H x L x W)	77 x 110 x 54 cm

**CAMIRA K** (deviating from Camira)

**TECHNICAL DATA**

Max. suction	180 mbar
Max. power vacuum	700 W
Max. power brush	300 W
Weight	66 kg



Power Pad.  
Item-no. 201076

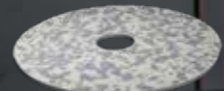

Duo Pad.  
Item-no. 201077



**Optional:**  
Pad holder and pads in different degrees of hardness.



Brush soft 17".  
Item-no. 210228



Brush medium 17".  
Item-no. 210230



Brush abrasive 17".  
Item-no. 210227



Brush horsehair 17".  
Item-no. 210226

**Tool free exchange of brushes:**  
The brushes have a fast opening mechanism and can be exchanged within seconds. There are different types of brushes with different degrees of hardness for different types of flooring.

	Item-no.	UK	EU
<b>CAMIRA</b>			
Brush medium, integrated onboard charger	210013	210006	
<b>CAMIRA K</b>			
Brush medium, cable version without battery	210014	210007	
<b>STANDARD KIT:</b>			
Brush medium 17"			210230
2 x 12V Sonnenschein gel-battery à 54 Ah (individual)			210121
<b>ACCESSORIES:</b>			
Brush soft 17"			210228
Brush abrasive 17"			210227
Brush horsehair 17"			210226
Pad white 17" (5 pieces/unit)			210105
Pad red 17" (5 pieces/unit)			210106
Pad green 17" (5 pieces/unit)			210108
Pad black 17" (5 pieces/unit)			210107
Pad holder with pad lock			210229
Power Pad 17"			210176
Duo Pad 17"			210177
Charging cable 1 m, red	210133	210132	

ACCESSORIES OVERVIEW, SEE PAGE 100-103 AND 111.









# Our brushes and pads

When cleaning with the single disc machines and floorscrubber dryers, besides the choice of the right cleaning machine, in particular the use of a suitable tool and the appropriate cleaning agent also plays a decisive role. In tools, a distinction is made between brushes and pads.

Here the rule is always that smooth flooring requires the use of a pad whereas textured flooring or floors with deep, wide joints require brushes. Both pads and brushes are available in various designs since the abrasiveness of the tool must suit the flooring.

## Brushes

The following table provides assistance with selecting the right tool for machine cleaning of floors. We offer you brushes in various hardness grades appropriate to your flooring.

	Description	Floor
Floor scrubber dryers	 Brush soft The bristles are made of polypropylene.	<ul style="list-style-type: none"> <li>Slightly structured floor coverings</li> <li>Aggregate concrete</li> <li>Rubber stud floors</li> <li>Floors with joints</li> </ul>
	 Brush medium The all-round brush with polypropylene bristles.	<ul style="list-style-type: none"> <li>All common waterproof, smooth and slightly structured surfaces with a medium degree of soiling</li> </ul>
	 Brush abrasive The hard, durable Tynex bristles are highly abrasive. This makes the brush suitable for removing stubborn dirt.	<ul style="list-style-type: none"> <li>Scratch-resistant floor coverings</li> <li>Hard floor coverings</li> </ul>
	 Brush horsehair For polishing, often after the work step cleaning or waxing of floor coverings.	<ul style="list-style-type: none"> <li>Porcelain stoneware</li> <li>Safety tiles</li> </ul>
Single disc machines	 Brush medium The all-round brush with polypropylene bristles.	<ul style="list-style-type: none"> <li>All common water-resistant surfaces with a medium degree of soiling</li> <li>Smooth and slightly structured surfaces</li> </ul>
	 Brush soft For shampooing and cleaning soft floors.	<ul style="list-style-type: none"> <li>Soft floors</li> <li>Sensitive floors</li> </ul>



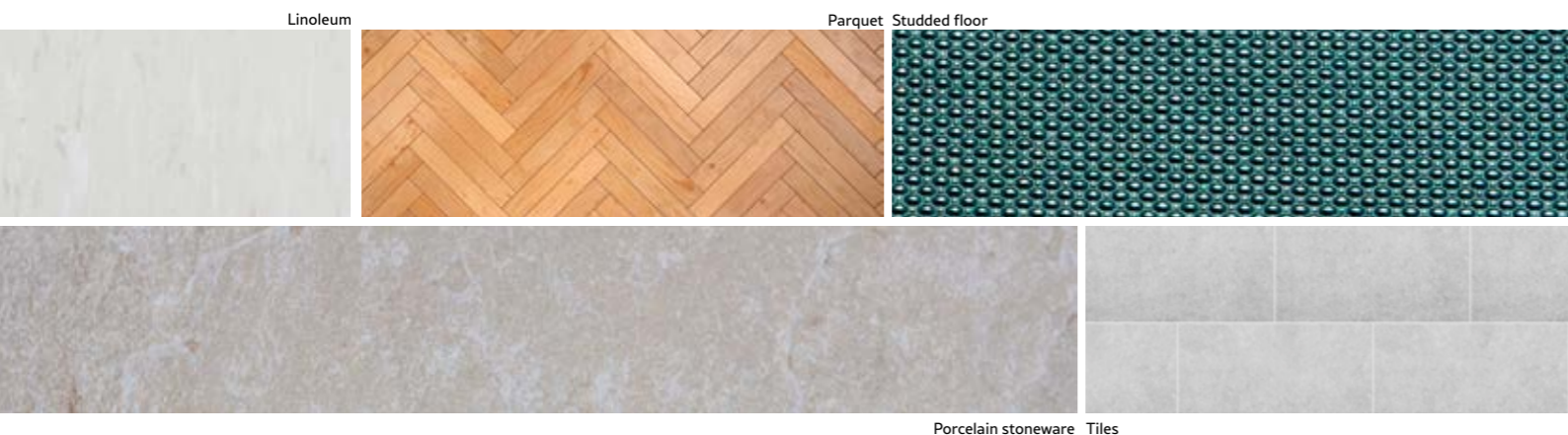



The statements made are only recommendations. Because of the differences in flooring, a specialist test on the properties is essential.



## Pads

Pads are used for removing dirt or coatings and for polishing floors. We offer you scrubbing pads in white, red, green and black as well as special pads. The rule with the coloured pads is that the darker the pad, the more abrasive it is, the greater the abrasion. Care is recom-

mended here since if a too-abrasive pad is used, this may cause damage and colour changes to the flooring. The following summary shows which pad is suitable for which type of floor.

	Description	Floor
Floor scrubber dryers	 Pad white For dry polishing of treated floors. Removes light deposits on smooth and coated surfaces. Suitable for maintenance cleaning.	<ul style="list-style-type: none"> <li>Tiles</li> <li>Coated floors</li> <li>Polishing of wooden parquet oiled/sealed</li> <li>Elastic floor coverings, e.g. linoleum, rubber, PVC, vinyl</li> </ul>
	 Pad red Scouring pad for everyday use. The all-rounder for maintenance cleaning.	<ul style="list-style-type: none"> <li>Water-resistant floor coverings</li> <li>Ground hard stone, e.g. granite</li> <li>Polished natural stone, e.g. marble</li> <li>Polished artificial stone, e.g. terrazzo</li> <li>Elastic floor coverings, e.g. linoleum, rubber, PVC, vinyl</li> </ul>
	 Pad green Abrasive cleaning pad for removing heavy to very heavy dirt. Suitable for basic cleaning and intermediate cleaning.	<ul style="list-style-type: none"> <li>Scratch-resistant floors</li> <li>Linoleum</li> <li>PVC</li> <li>Wood parquet oiled/sealed</li> <li>Hardwood decking</li> </ul>
	 Pad black Very abrasive cleaning pad for basic cleaning. Suitable for stripping floor coverings. Should only be used if the green pad does not produce the desired cleaning result.	<ul style="list-style-type: none"> <li>Very scratch-resistant floors</li> <li>Polished granite</li> <li>PVC with heavy incrustations</li> <li>Concrete</li> <li>Screed</li> <li>Wood parquet sanding</li> </ul>
	 Duo Pad For efficient intensive cleaning.	<ul style="list-style-type: none"> <li>Porcelain stoneware</li> <li>Cast stone</li> <li>Natural stone</li> <li>Terracotta</li> <li>Coated concrete</li> <li>Textured safety tiles</li> </ul>
Single disc machines	 Power Pad Durable all-rounder for all types of hard floor coverings.	<ul style="list-style-type: none"> <li>Tiles</li> <li>Safety tiles</li> <li>Stone floors</li> <li>Porcelain stoneware</li> <li>Concrete floors</li> <li>Vinyl</li> <li>PVC</li> <li>Linoleum</li> </ul>
	 Queen Bonnet Pad Special pad for cleaning textile floor coverings and carpets. Used for superficial cleaning or quick visual improvement.	<ul style="list-style-type: none"> <li>Carpet coverings</li> </ul>

The statements made are only recommendations. Because of the differences in flooring, a specialist test on the properties is essential.



# Single disc/orbital/scrubbing machines

## Brushes, pads and pad holders

### Pad holder and brushes 13" EEM 13 R



Pad holder.  
Item-no. 202010



Brush medium.  
Item-no. 202011



Brush soft.  
Item-no. 202012

### 17" EM17 EVO, Hercules, Zeus



Pad holder.  
Item-no. 205122



Brush medium.  
Item-no. 205121



Brush soft.  
Item-no. 205120

### 17" TITAN



Pad holder.  
Item-no. 207113



Brush medium.  
Item-no. 207115

### 15" TORANA

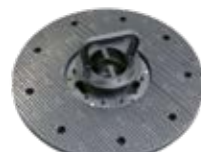

Pad holder.  
Item-no. 210426



Brush soft.  
Item-no. 210429



Brush medium.  
Item-no. 210427



Brush abrasive.  
Item-no. 210428



Brush horsehair.  
Item-no. 210430

### 17" CAMIRA



Pad holder.  
Item-no. 210229



Brush soft.  
Item-no. 210228



Brush medium.  
Item-no. 210230



Brush abrasive.  
Item-no. 210227



Brush horsehair.  
Item-no. 210226

### Pads and additional weight

Disc pads for each surface in different degrees of hardness.



white



red



green



black



Duo Pad

Suitability:  
Porcelain stoneware, cast stone, natural stone, Terracotta, coated concrete, textured Security tiles and similar materials.



Power Pad

Suitability:  
The durable all-rounder for all types of hard floor coverings such as tiles, safety tiles, stone floors, porcelain stoneware, concrete floors, vinyl floors, PVC and linoleum.



Queen Bonnet Pad

Suitability:  
The Queen Bonnet Pad for the best cleaning results on carpets and carpeted floors.

### Additional weight



**EM 17 EVO**  
Additional weight 14 kg.  
Item-no. 201068

**HERCULES**  
Additional weight 14 kg.  
Item-no. 205123



**TITAN**  
Additional weight 12 kg.  
Item-no. 207119

Description	Ø size	unit	Item-no.	EM 17 EVO	Hercules /heavy	Hercules Duo	Zeus	EEM 13 R	Titan / heavy	Torana	Camira
<b>Pads &amp; Pad holders</b>											
Pad holder EEM 13 R	13 inch		202010					■			
Pad holder incl. pad lock Torona	15 inch		210426							□	
Pad holder EM 17 EVO/ Hercules/ Zeus	16-17 inch		205122	■	■	■	■				
Pad holder incl. pad lock Camira	17 inch		210229								□
Pad holder Titan	17 inch		207113						■		
Pad white	13 inch	5 pieces	202033					□			
Pad green	13 inch	5 pieces	202032					□			
Pad red	13 inch	5 pieces	202035					□			
Pad black	13 inch	5 pieces	202036					□			
Queen Bonnet Pad	13 inch		202034					□			
Pad white	15 inch	5 pieces	210122							□	
Pad green	15 inch	5 pieces	210124							□	
Pad red	15 inch	5 pieces	210131							□	
Pad black	15 inch	5 pieces	210123							□	
Pad white	17 inch	5 pieces	201005	□	□	□	□		□		□
Pad green	17 inch	5 pieces	201008	□	□	□	□		□		□
Pad red	17 inch	5 pieces	201006	□	□	□	□		□		□
Pad black	17 inch	5 pieces	201007	□	□	□	□		□		□
Queen Bonnet Pad	17 inch		201009	□	□	□	□		□		□
Duo Pad	15 inch		210243							□	
Duo Pad	17 inch		201077	□	□						□
Power Pad	13 inch		202039					□			
Power Pad	17 inch		201076	□	□				■		□

Brushes	Ø size	Item-no.	EM 17 EVO	Hercules /heavy	Hercules Duo	Zeus	EEM 13 R	Titan / heavy	Torana	Camira
Brush medium	13 inch	202011					■			
Brush soft	13 inch	202012					■			
Brush medium	17 inch	205121	■	■	■	■				
Brush soft	17 inch	205120	■	■	■	■				
Brush medium	17 inch	207115						□		
Brush soft	15 inch	210429							□	
Brush medium	15 inch	210427							■	
Brush abrasive	15 inch	210428							□	
Brush horsehair	15 inch	210430							□	
Brush soft	17 inch	210228								□
Brush medium	17 inch	210230								■
Brush abrasive	17 inch	210227								□
Brush horsehair	17 inch	210226								□

■ standard equipment □ accessories



# SE 7

Spray-extraction cleaner with a separate anti-foaming tank.

### Suggested Use

Designed for rug, carpet, and upholstery cleaning in offices, clinics, cinemas and households, as well as car upholstery.

With 4 bar spraying pressure and 230 mbar suction pressure, the SE 7 cleans quickly and thoroughly. The spray function can be turned on or off with the valve lever near the handle. The liquid levels of both the 6.5 litres fresh- and wastewater tanks can be checked at any time through the transparent lid of the device. Both tanks are separately removable for easy filling or emptying. A third, integrated container allows the use of anti-foaming agent.

The clear upholstery and floor nozzle allows free sight of the surface being cleaned and constant control over the process. Its ergonomic form guarantees effortless work.

The 7.5 m power cord ensures a large working range and can be rolled up on the cleaner handle after use. The body of the cleaner is made of impact-resistant plastic and is equipped with large, rubber-coated wheels, which leave no traces even on all sensitive surfaces.

### Features

- Thorough cleaning through the 4 bar spray pressure and 230 mbar suction power
- Spray and extraction functions are separately operable
- Separate fresh- and wastewater tanks, each containing 6.5 L
- Separate container for anti-foaming agent
- Clear, ergonomic nozzles
- Long stainless steel vacuum tube for convenient, effortless work
- Rubber-coated castor wheels and large back wheels for streak-free work



Spray-and vacuum-function are separately switchable at the device.



A separate tank allows for the use of anti-foaming agent and guarantees problem-free work.

### Functional principle:



Cleaning agent is sprayed on as needed.



Subsequent vacuuming up of the dirt, including liquid.



Clear upholstery nozzle for cleaning vehicle seats etc. The spray function can be adjusted via the operating lever on grip.



Large rubberwheels for silent running on tiles and mark free running on sensitive surfaces.



The floor spray nozzle with a long vacuum tube for convenient carpet cleaning.

### TECHNICAL DATA

Voltage	220-240 V / 50 Hz
Max. power	1100 W
Power pump	50 W
Max. suction	230 mbar
Sound pressure level	65 LpA [dB]
Spray pressure	4 bar
Water tank volume	each 6,5 litres
Length of power cord	7,5 m
Length of vacuum hose	2,5 m
Diameter of hose	38 mm
Diameter of tubes	38 mm
Weight	13 kg
Dimensions (L x W x H)	55 x 35 x 63,5 cm

### SE 7 SPRAY-EXTRACTION CLEANER

Item-no.	UK	EU
107008		107001

2 x 0,5 m suction tubes stainless steel ø 38 mm,  
2,5 m combi suction hose,  
floor nozzle with a width of 250 mm,  
upholstery nozzle with a width of 105 mm,  
defoaming tank, 7,5 m power cord

### STANDARD KIT:

Upholstery nozzle 105 mm	107011
Floor nozzle 250 mm	107010
1 x suction tube stainless steel	107013
2,5 m combi suction hose	107012
7,5 m power cord	107045
	107022

ACCESSORIES OVERVIEW, see page 111.



## Dry vacuum cleaners Accessories

Description	Ø Size	unit	Item-no.	Item-no. UK	ARES	FLOORY	ERA EVO	ERA TEC	ERA PRO	ERA IGO	Maximus pt	BOOSTIX
<b>Fleece filter bags / fleece filter baskets</b>												
Fleece filter bag		10 pieces	115113		<input type="checkbox"/>							
Fleece filter bag		10 pieces	106013			<input type="checkbox"/>	<input type="checkbox"/>	<input type="checkbox"/>	<input type="checkbox"/>	<input type="checkbox"/>	<input type="checkbox"/>	
Fleece filter bag		250 pieces	106014			<input type="checkbox"/>	<input type="checkbox"/>	<input type="checkbox"/>	<input type="checkbox"/>	<input type="checkbox"/>	<input type="checkbox"/>	
HEPA13 Fleece filter bag		10 pieces	106061			<input type="checkbox"/>	<input type="checkbox"/>	<input type="checkbox"/>	<input type="checkbox"/>	<input type="checkbox"/>	<input type="checkbox"/>	
HEPA13 Fleece filter bag		10 pieces	119102									<input type="checkbox"/>
Fleece filter basket			115118		<input checked="" type="checkbox"/>							
Fleece filter basket			111125								<input checked="" type="checkbox"/>	
HEPA13 Fleece filter basket			114118			<input checked="" type="checkbox"/>						
HEPA13 Fleece filter basket			117101				<input checked="" type="checkbox"/>	<input checked="" type="checkbox"/>	<input checked="" type="checkbox"/>	<input checked="" type="checkbox"/>		
Filter basket			119103									<input checked="" type="checkbox"/>
HEPA13 filter cartridge			111132				<input checked="" type="checkbox"/>	<input checked="" type="checkbox"/>	<input checked="" type="checkbox"/>	<input checked="" type="checkbox"/>	<input type="checkbox"/>	
HEPA14 filter cartridge			111193				<input type="checkbox"/>	<input type="checkbox"/>	<input type="checkbox"/>	<input type="checkbox"/>	<input type="checkbox"/>	
Engine fleece filter			106047			<input checked="" type="checkbox"/>	<input checked="" type="checkbox"/>	<input checked="" type="checkbox"/>	<input checked="" type="checkbox"/>	<input checked="" type="checkbox"/>	<input checked="" type="checkbox"/>	
Engine fleece filter			115117		<input checked="" type="checkbox"/>							
Case for filterbag			117117				<input type="checkbox"/>	<input checked="" type="checkbox"/>	<input checked="" type="checkbox"/>	<input checked="" type="checkbox"/>		
Filter sponge set			119106									<input checked="" type="checkbox"/>
<b>Nozzles</b>												
Combi nozzle 280 mm	32 mm		114114		<input checked="" type="checkbox"/>	<input checked="" type="checkbox"/>	<input checked="" type="checkbox"/>	<input checked="" type="checkbox"/>	<input checked="" type="checkbox"/>	<input checked="" type="checkbox"/>	<input type="checkbox"/>	<input checked="" type="checkbox"/>
Combi nozzle 270 mm	32 mm		106027		<input type="checkbox"/>	<input type="checkbox"/>	<input type="checkbox"/>	<input type="checkbox"/>	<input type="checkbox"/>	<input type="checkbox"/>	<input type="checkbox"/>	<input type="checkbox"/>
Combi nozzle 306 mm	32 mm		111307		<input type="checkbox"/>	<input type="checkbox"/>	<input type="checkbox"/>	<input type="checkbox"/>	<input type="checkbox"/>	<input type="checkbox"/>	<input type="checkbox"/>	<input type="checkbox"/>
Parquet nozzle 360 mm horse hair with parking hook	32 mm		111207		<input type="checkbox"/>	<input type="checkbox"/>	<input type="checkbox"/>	<input type="checkbox"/>	<input type="checkbox"/>	<input type="checkbox"/>	<input type="checkbox"/>	<input type="checkbox"/>
Hard floor nozzle 360 mm with parking hook	32 mm		111202		<input type="checkbox"/>	<input type="checkbox"/>	<input type="checkbox"/>	<input type="checkbox"/>	<input type="checkbox"/>	<input type="checkbox"/>	<input type="checkbox"/>	<input type="checkbox"/>
Flat floor nozzle 280 mm	32 mm		119126		<input type="checkbox"/>	<input type="checkbox"/>	<input type="checkbox"/>	<input type="checkbox"/>	<input type="checkbox"/>	<input type="checkbox"/>	<input type="checkbox"/>	<input type="checkbox"/>
Turbo brush 284 mm	32 mm		106012		<input type="checkbox"/>	<input type="checkbox"/>	<input type="checkbox"/>	<input type="checkbox"/>	<input type="checkbox"/>	<input type="checkbox"/>	<input type="checkbox"/>	<input type="checkbox"/>
Turbo upholstery brush 160 mm	32 mm		111190		<input type="checkbox"/>	<input type="checkbox"/>	<input type="checkbox"/>	<input type="checkbox"/>	<input type="checkbox"/>	<input type="checkbox"/>	<input type="checkbox"/>	<input type="checkbox"/>
2in1 upholstery nozzle 115 mm	32 mm		117294		<input type="checkbox"/>	<input type="checkbox"/>	<input checked="" type="checkbox"/>	<input checked="" type="checkbox"/>	<input checked="" type="checkbox"/>	<input checked="" type="checkbox"/>	<input checked="" type="checkbox"/>	<input type="checkbox"/>
Round nozzle	32 mm		101024		<input type="checkbox"/>	<input type="checkbox"/>	<input type="checkbox"/>	<input type="checkbox"/>	<input type="checkbox"/>	<input type="checkbox"/>	<input checked="" type="checkbox"/>	<input type="checkbox"/>
Crevice nozzle	32 mm		101023		<input type="checkbox"/>	<input type="checkbox"/>	<input checked="" type="checkbox"/>	<input checked="" type="checkbox"/>	<input checked="" type="checkbox"/>	<input checked="" type="checkbox"/>	<input checked="" type="checkbox"/>	<input type="checkbox"/>
Flexible Crevice nozzle 600 mm	32 mm		111203		<input type="checkbox"/>	<input type="checkbox"/>	<input type="checkbox"/>	<input type="checkbox"/>	<input type="checkbox"/>	<input type="checkbox"/>	<input type="checkbox"/>	<input type="checkbox"/>
2in1 crevice-/ upholstery nozzle	32 mm		115127		<input checked="" type="checkbox"/>	<input checked="" type="checkbox"/>	<input type="checkbox"/>	<input type="checkbox"/>	<input type="checkbox"/>	<input type="checkbox"/>	<input type="checkbox"/>	<input checked="" type="checkbox"/>
<b>Brush strips</b>												
Set of brush strips 360mm for 111207 (horse hair)			101104		<input type="checkbox"/>	<input type="checkbox"/>	<input type="checkbox"/>	<input type="checkbox"/>	<input type="checkbox"/>	<input type="checkbox"/>	<input type="checkbox"/>	<input type="checkbox"/>
Set of brush strips 360mm for 101106, 111202			101100		<input type="checkbox"/>	<input type="checkbox"/>	<input type="checkbox"/>	<input type="checkbox"/>	<input type="checkbox"/>	<input type="checkbox"/>	<input type="checkbox"/>	<input type="checkbox"/>
Plastic rail 360mm for set 101106 und 111202			101105		<input type="checkbox"/>	<input type="checkbox"/>	<input type="checkbox"/>	<input type="checkbox"/>	<input type="checkbox"/>	<input type="checkbox"/>	<input type="checkbox"/>	<input type="checkbox"/>
<b>Suction hoses</b>												
Suction hose complete 2,5 m	32 mm		114113		<input type="checkbox"/>	<input type="checkbox"/>	<input type="checkbox"/>	<input checked="" type="checkbox"/>	<input checked="" type="checkbox"/>	<input type="checkbox"/>	<input checked="" type="checkbox"/>	<input type="checkbox"/>
Suction hose complete 1,3 m	32 mm		119124		<input type="checkbox"/>	<input type="checkbox"/>	<input type="checkbox"/>	<input type="checkbox"/>	<input type="checkbox"/>	<input type="checkbox"/>	<input type="checkbox"/>	<input checked="" type="checkbox"/>
Suction hose, 3 m, antistatic	32 mm		109111		<input type="checkbox"/>	<input type="checkbox"/>	<input type="checkbox"/>	<input type="checkbox"/>	<input type="checkbox"/>	<input type="checkbox"/>	<input type="checkbox"/>	<input type="checkbox"/>
Suction hose / price per meter	32 mm		106044		<input type="checkbox"/>	<input type="checkbox"/>	<input type="checkbox"/>	<input type="checkbox"/>	<input type="checkbox"/>	<input type="checkbox"/>	<input type="checkbox"/>	<input type="checkbox"/>
Handle, antistatic incl. connection sleeve	32 mm		117148		<input type="checkbox"/>	<input type="checkbox"/>	<input type="checkbox"/>	<input type="checkbox"/>	<input type="checkbox"/>	<input type="checkbox"/>	<input type="checkbox"/>	<input type="checkbox"/>
Suction hose, 2 m, antistatic	32 mm		120124		<input type="checkbox"/>	<input type="checkbox"/>	<input type="checkbox"/>	<input type="checkbox"/>	<input type="checkbox"/>	<input checked="" type="checkbox"/>	<input type="checkbox"/>	<input type="checkbox"/>
<b>Tubes</b>												
Aluminium tube	32 mm		106026		<input type="checkbox"/>	<input checked="" type="checkbox"/>	<input checked="" type="checkbox"/>	<input type="checkbox"/>	<input type="checkbox"/>	<input type="checkbox"/>	<input checked="" type="checkbox"/>	<input type="checkbox"/>
Telescopic tube, stainless steel	32 mm		117228		<input type="checkbox"/>	<input type="checkbox"/>	<input type="checkbox"/>	<input checked="" type="checkbox"/>	<input checked="" type="checkbox"/>	<input checked="" type="checkbox"/>	<input type="checkbox"/>	<input checked="" type="checkbox"/>
Aluminium tube single, extra long 535 mm	32 mm		106062		<input type="checkbox"/>	<input type="checkbox"/>	<input type="checkbox"/>	<input type="checkbox"/>	<input type="checkbox"/>	<input type="checkbox"/>	<input type="checkbox"/>	<input type="checkbox"/>
<b>Power cords</b>												
Power cord 8 m black			115115	115128	<input checked="" type="checkbox"/>							
Power cord 10 m black			106017		<input type="checkbox"/>							
Power cord 10 m black			111155	111192							<input checked="" type="checkbox"/>	
Power cord 10 m pluggable, black			111128	114124		<input checked="" type="checkbox"/>	<input type="checkbox"/>	<input type="checkbox"/>	<input type="checkbox"/>			
Power cord 15 m pluggable, black			111159			<input type="checkbox"/>						
Power cord 10 m pluggable, red			111310			<input type="checkbox"/>	<input checked="" type="checkbox"/>	<input type="checkbox"/>	<input type="checkbox"/>			
Power cord 10 m pluggable, red				111177		<input type="checkbox"/>	<input checked="" type="checkbox"/>	<input checked="" type="checkbox"/>	<input checked="" type="checkbox"/>			
Power cord 12 m pluggable, red			117133			<input type="checkbox"/>	<input type="checkbox"/>	<input checked="" type="checkbox"/>	<input checked="" type="checkbox"/>			
Power cord 15 m pluggable, red			119119	119127								<input checked="" type="checkbox"/>
Power cord 15 m pluggable, red			111172			<input type="checkbox"/>						
<b>Suction engines</b>												
Suction engine 700 W			115116		<input checked="" type="checkbox"/>							
Suction engine 700 W			114109			<input checked="" type="checkbox"/>	<input checked="" type="checkbox"/>	<input checked="" type="checkbox"/>	<input checked="" type="checkbox"/>			
Suction engine 700 W			111324								<input checked="" type="checkbox"/>	
Suction engine 890 W for mains version 220-240 V			119100									<input checked="" type="checkbox"/>
Suction engine 300 W EC-Motor for battery version 36 V			119101									<input checked="" type="checkbox"/>
Suction engine 300 W EC-Motor for battery version 36 V			120100							<input checked="" type="checkbox"/>		

■ standard accessories □ optional accessories





## Wet and dry vacuum cleaners Accessories

Description	Ø Size	unit	Item-no.	ARTOS	WATERKING	WATERKING XL	N 55/2 E	N 77/3 E	N 80/2 K	Ketos N 56/2 E	Ketos N 81/2 K	CRAFTIX
<b>Fleece filter bags / fleece filter baskets</b>												
Fleece filter bag		5 pieces	101020	<input type="checkbox"/>	<input type="checkbox"/>							
Fleece filter bag		5 pieces	102031			<input type="checkbox"/>	<input type="checkbox"/>			<input type="checkbox"/>		<input type="checkbox"/>
Fleece filter bag		5 pieces	102072					<input type="checkbox"/>	<input type="checkbox"/>			<input type="checkbox"/> *
EPA12 filter cartridge			112101							<input type="checkbox"/>	<input type="checkbox"/>	
HEPA13 filter cartridge			118100									<input type="checkbox"/>
HEPA14 filter cartridge			118166									<input type="checkbox"/>
* CraftiX 50 litres only												
<b>Nozzles</b>												
Wet floor nozzle 360 mm with parking hook	32 mm		101106	<input checked="" type="checkbox"/>								
Hard floor nozzle 360 mm with parking hook	32 mm		111202	<input type="checkbox"/>								
Combi nozzle 270 mm	32 mm		106027	<input type="checkbox"/>								
Combi nozzle 306 mm	32 mm		111307	<input type="checkbox"/>								
Turbo brush 284 mm	32 mm		106012	<input type="checkbox"/>								
Turbo upholstery brush	32 mm		111190	<input type="checkbox"/>								
2 in 1 upholstery nozzle 115 mm	32 mm		117294	<input type="checkbox"/>								
Round nozzle	32 mm		101024	<input checked="" type="checkbox"/>								
Crevice nozzle 240 mm	32 mm		101023	<input checked="" type="checkbox"/>								
Flexible Crevice nozzle 600 mm	32 mm		111203	<input type="checkbox"/>								
Wet floor nozzle 360 mm with parking hook	38 mm		109114	<input checked="" type="checkbox"/>	<input type="checkbox"/>	<input type="checkbox"/>	<input type="checkbox"/>	<input type="checkbox"/>	<input type="checkbox"/>	<input type="checkbox"/>	<input type="checkbox"/>	<input type="checkbox"/>
Hard floor nozzle 360 mm with parking hook	38 mm		109071	<input checked="" type="checkbox"/>	<input type="checkbox"/>	<input type="checkbox"/>	<input type="checkbox"/>	<input type="checkbox"/>	<input type="checkbox"/>	<input type="checkbox"/>	<input type="checkbox"/>	<input type="checkbox"/>
Wet floor nozzle 400 mm	38 mm		102109	<input type="checkbox"/>	<input type="checkbox"/>	<input type="checkbox"/>	<input type="checkbox"/>	<input type="checkbox"/>	<input type="checkbox"/>	<input type="checkbox"/>	<input type="checkbox"/>	<input type="checkbox"/>
Wet floor nozzle 450 mm with parking hook	38 mm		102124	<input type="checkbox"/>	<input checked="" type="checkbox"/>	<input checked="" type="checkbox"/>	<input checked="" type="checkbox"/>	<input checked="" type="checkbox"/>	<input checked="" type="checkbox"/>	<input checked="" type="checkbox"/>	<input checked="" type="checkbox"/>	<input type="checkbox"/>
Hard floor nozzle 450 mm with parking hook	38 mm		102125	<input type="checkbox"/>	<input checked="" type="checkbox"/>	<input checked="" type="checkbox"/>	<input checked="" type="checkbox"/>	<input checked="" type="checkbox"/>	<input checked="" type="checkbox"/>	<input checked="" type="checkbox"/>	<input checked="" type="checkbox"/>	<input checked="" type="checkbox"/>
Combi nozzle 307 mm with parking hook	38 mm		109084	<input type="checkbox"/>	<input type="checkbox"/>	<input type="checkbox"/>	<input type="checkbox"/>	<input type="checkbox"/>	<input type="checkbox"/>	<input type="checkbox"/>	<input type="checkbox"/>	<input type="checkbox"/>
Floor nozzle metal 450 mm	38 mm		102051	<input type="checkbox"/>	<input type="checkbox"/>	<input type="checkbox"/>	<input type="checkbox"/>	<input type="checkbox"/>	<input type="checkbox"/>	<input type="checkbox"/>	<input type="checkbox"/>	<input type="checkbox"/>
Round nozzle	38 mm		102017	<input checked="" type="checkbox"/>	<input checked="" type="checkbox"/>	<input checked="" type="checkbox"/>	<input checked="" type="checkbox"/>	<input checked="" type="checkbox"/>	<input checked="" type="checkbox"/>	<input checked="" type="checkbox"/>	<input checked="" type="checkbox"/>	<input checked="" type="checkbox"/>
Crevice nozzle 240 mm	38 mm		102016	<input checked="" type="checkbox"/>	<input checked="" type="checkbox"/>	<input checked="" type="checkbox"/>	<input checked="" type="checkbox"/>	<input checked="" type="checkbox"/>	<input checked="" type="checkbox"/>	<input checked="" type="checkbox"/>	<input checked="" type="checkbox"/>	<input checked="" type="checkbox"/>
Gangway nozzle 650 mm	38 mm		102010			<input type="checkbox"/>			<input type="checkbox"/>			
Gangway nozzle 650 mm	38 mm		103010				<input type="checkbox"/>					
<b>Brush strips and spare lips</b>												
Set of brush strips 360 mm for 111202			101100	<input type="checkbox"/>	<input type="checkbox"/>							
Spare lip for wet floor nozzle 360 mm for 101106, 109119 (individual)			101101	<input type="checkbox"/>	<input type="checkbox"/>							
Spare lip for wet floor nozzle 360 mm for 101087, 109070, 102015 (individual)			109074	<input type="checkbox"/>								
Set of brush strips 450 mm for 102119			102114	<input type="checkbox"/>	<input type="checkbox"/>	<input type="checkbox"/>	<input type="checkbox"/>	<input type="checkbox"/>	<input type="checkbox"/>	<input type="checkbox"/>	<input type="checkbox"/>	<input type="checkbox"/>
Spare lip set 450 mm for 102118			102115	<input type="checkbox"/>	<input type="checkbox"/>	<input type="checkbox"/>	<input type="checkbox"/>	<input type="checkbox"/>	<input type="checkbox"/>	<input type="checkbox"/>	<input type="checkbox"/>	<input type="checkbox"/>
Set of brush strips 450 mm for 102125			102127	<input type="checkbox"/>	<input type="checkbox"/>	<input type="checkbox"/>	<input type="checkbox"/>	<input type="checkbox"/>	<input type="checkbox"/>	<input type="checkbox"/>	<input type="checkbox"/>	<input type="checkbox"/>
Spare lip set 450 mm for 102124			102126	<input type="checkbox"/>	<input type="checkbox"/>	<input type="checkbox"/>	<input type="checkbox"/>	<input type="checkbox"/>	<input type="checkbox"/>	<input type="checkbox"/>	<input type="checkbox"/>	<input type="checkbox"/>
<b>Suction hoses</b>												
Suction hose complete 2,5 m	32 mm		114113	<input checked="" type="checkbox"/>								
Suction hose complete, oil resistant, antistatic, 3 m	32 mm		109111	<input type="checkbox"/>								
Suction hose complete, oil resistant, antistatic, 3 m	32 mm		109112		<input type="checkbox"/>							
Suction hose price per meter, oil resistant, antistatic	32 mm		106067	<input type="checkbox"/>	<input type="checkbox"/>							
Suction hose complete, oil resistant, antistatic, 5 m	35 mm		118143			<input type="checkbox"/>	<input type="checkbox"/>	<input type="checkbox"/>	<input type="checkbox"/>	<input type="checkbox"/>	<input type="checkbox"/>	<input checked="" type="checkbox"/>
Suction hose complete 2,5 m	38 mm		109069		<input checked="" type="checkbox"/>							
Suction hose complete 3 m	38 mm		102013			<input checked="" type="checkbox"/>	<input checked="" type="checkbox"/>	<input checked="" type="checkbox"/>	<input checked="" type="checkbox"/>	<input checked="" type="checkbox"/>	<input checked="" type="checkbox"/>	<input type="checkbox"/> *
Suction hose complete, oil resistant, antistatic 3 m	38 mm		118193			<input type="checkbox"/>	<input type="checkbox"/>	<input type="checkbox"/>	<input type="checkbox"/>	<input type="checkbox"/>	<input type="checkbox"/>	<input checked="" type="checkbox"/> *
Suction hose price per meter, oil resistant, antistatic	38 mm		102111			<input type="checkbox"/>	<input type="checkbox"/>	<input type="checkbox"/>	<input type="checkbox"/>	<input type="checkbox"/>	<input type="checkbox"/>	<input type="checkbox"/>
Suction hose complete 7 m	38 mm		110049			<input type="checkbox"/>	<input type="checkbox"/>	<input type="checkbox"/>	<input type="checkbox"/>	<input type="checkbox"/>	<input type="checkbox"/>	<input type="checkbox"/>
Suction hose complete 15 m	38 mm		102032			<input type="checkbox"/>	<input type="checkbox"/>	<input type="checkbox"/>	<input type="checkbox"/>	<input type="checkbox"/>	<input type="checkbox"/>	<input type="checkbox"/>
Suction hose price per meter	38 mm		102057			<input type="checkbox"/>	<input type="checkbox"/>	<input type="checkbox"/>	<input type="checkbox"/>	<input type="checkbox"/>	<input type="checkbox"/>	<input type="checkbox"/>
* CraftiX M only												
<b>Suction tubes</b>												
Aluminium tube 0,5 m (1 piece)	32 mm		106026	<input checked="" type="checkbox"/>								
Telescopic tube, stainless steel (1 piece)	32 mm		117228	<input type="checkbox"/>								
Aluminium tube (1 piece) length 535 mm	32 mm		106062	<input type="checkbox"/>								
Vacuum tubes, stainless steel (1 piece)	38 mm		102018		<input checked="" type="checkbox"/>	<input checked="" type="checkbox"/>	<input checked="" type="checkbox"/>	<input checked="" type="checkbox"/>	<input checked="" type="checkbox"/>	<input checked="" type="checkbox"/>	<input checked="" type="checkbox"/>	<input checked="" type="checkbox"/>

■ standard accessories □ optional accessories

## Wet and dry vacuum cleaners Accessories

Description	Item-no.	Item-no. UK	ARTOS	WATERKING	WATERKING XL	N 55/2 E	N 77/3 E	N 80/2 K	Ketos N 56/2 E	Ketos N 81/2 K	CRAFTIX
<b>Power cords</b>											
Power cord 7,5 m, black	101074	101107	<input checked="" type="checkbox"/>								
Power cord 10 m, black	109910	109919		<input checked="" type="checkbox"/>	<input checked="" type="checkbox"/>						
Power cord 15 m, black	103023	103040				<input checked="" type="checkbox"/>	<input checked="" type="checkbox"/>	<input checked="" type="checkbox"/>			
Power cord 10 m, black	112135	112149							<input checked="" type="checkbox"/>	<input checked="" type="checkbox"/>	
Power cord 10 m, black	118110	118152									<input checked="" type="checkbox"/>
<b>Suction engine</b>											
Suction engine 1200 W	116108		<input checked="" type="checkbox"/>								<input type="checkbox"/>
Suction engine 1200 W	102026					<input checked="" type="checkbox"/>	<input checked="" type="checkbox"/>	<input checked="" type="checkbox"/>			<input type="checkbox"/>
Suction engine 1300 W	109117			<input checked="" type="checkbox"/>	<input checked="" type="checkbox"/>				<input checked="" type="checkbox"/>	<input checked="" type="checkbox"/>	<input type="checkbox"/>

■ standard accessories □ optional accessories





## Single disc/orbital machines Accessories

Description	Ø Size	unit	Item-no.	Item-no. UK	EM 17 EVO	Hercules / heavy	Hercules Duo	Zeus	EEM 13 R	Titan / heavy
<b>Pads &amp; pad holders</b>										
Pad-holder EM 17 EVO/ Hercules/ Zeus	17 inch		205122		■	■	■	■		
Pad-holder EEM 13 R	13 inch		202010						■	
Pad-holder Titan	17 inch		207113							■
Pad white	13 inch	5 pieces	202033						□	
Pad green	13 inch	5 pieces	202032						□	
Pad red	13 inch	5 pieces	202035						□	
Pad black	13 inch	5 pieces	202036						□	
Queen Bonnet Pad	13 inch		202034						□	
Pad white	17 inch	5 pieces	201005		□	□	□	□		□
Pad green	17 inch	5 pieces	201008		□	□	□	□		□
Pad red	17 inch	5 pieces	201006		□	□	□	□		□
Pad black	17 inch	5 pieces	201007		□	□	□	□		□
Queen Bonnet Pad	17 inch		201009		□	□				□
Duo Pad	17 inch		201077		□					
Power Pad	13 inch		202039					□		
Power Pad	17 inch		201076		□	□		□		■
<b>Brushes</b>										
Brush medium	13 inch		202011							■
Brush soft	13 inch		202012							■
Brush medium	17 inch		205121		■	■	■	■		
Brush soft	17 inch		205120		■	■	■	■		
Brush medium	17 inch		207115							□
<b>Power cord</b>										
Power cord 12 m, red			201030	201080	■	■	■	■		■
Power cord 7,5m, red			202038	202043					■	
<b>Engines</b>										
Engine complete			202022							■
Engine complete			203102		■					
Engine complete			205140			■				
Engine complete			207100							■
Engine complete			208102				■			

## Pump vacuum / Fire service vacuum Accessories

Description	Ø Size	Item-no.	Item-no. UK	N 51/1 KPS	HEROS
<b>Nozzles</b>					
Wet floor nozzle 360 mm	38 mm	109114		■	□
Wet floor nozzle 450 mm with parking hook	38 mm	102124		□	□
Pond nozzle	38 mm	110052		■	□
Floor nozzle metal 450 mm	38 mm	102051		□	■
Crevice nozzle	38 mm	102016		■	■
<b>Suction hoses</b>					
Suction hose complete 7 m	38 mm	110049		■	■
C-hose pump side complete 10 m	38 mm	110053		■	■
Vacuum hose per meter	38 mm	102057		□	□
<b>Pipes</b>					
Vacuum tubes, stainless steel, (1 piece)	38 mm	102018		□	■
Vacuum tubes, plastic, (1 piece)	38 mm	110047		■	□
<b>Power cords</b>					
Power cord 10 m, black incl. FI safety switch		110072	110091	■	
Power cord 10 m, black IP 68 incl. FI safety switch		113104			■
<b>Engines</b>					
Engine 1100 W incl. seal		109117		■	■

■ standard accessories □ optional accessories

## Floor scrubber dryers Accessories

Description	Ø Size	unit	Item-no.	Item-no. UK	Torana	Camira
<b>Pads &amp; pad holders</b>						
Pad-Treibteller inkl. Padverschluss Torana	15 inch		210426		□	
Pad-Treibteller inkl. Padverschluss Camira	17 inch		210229			□
Pad white	15 inch	5 pieces	210122		□	
Pad green	15 inch	5 pieces	210124		□	
Pad red	15 inch	5 pieces	210131		□	
Pad black	15 inch	5 pieces	210123		□	
Pad white	17 inch	5 pieces	201005			□
Pad green	17 inch	5 pieces	201008			□
Pad red	17 inch	5 pieces	201006			□
Pad black	17 inch	5 pieces	201007			□
Duo Pad	15 inch		210243		□	
Duo Pad	17 inch		201077			□
Power Pad	17 inch		201076			□
<b>Brushes</b>						
Brush soft	15 inch		210429		□	
Brush medium	15 inch		210427		■	
Brush abrasive	15 inch		210428		□	
Brush horsehair	15 inch		210430		□	
Brush soft	17 inch		210228			□
Brush medium	17 inch		210230			■
Brush abrasive	17 inch		210227			□
Brush horsehair	17 inch		210226			□
<b>Power cord</b>						
Charging cable 1 m, red			210030	201133	■	■
<b>Squeegees</b>						
Frontside squeegee, oil resistant			210248			□
backside squeegee, oil resistant			210249			□
Frontside squeegee, oil resistant			210435		□	
Backside squeegee, oil resistant			210436		□	

## Spray-extraction cleaner Accessories

Description	Ø Size	Item-no.	Item-no. UK	SE 7
<b>Nozzles</b>				
Floor nozzle	38 mm	107010		■
Upholstery nozzle	38 mm	107011		■
<b>Suction hoses</b>				
Suction hose complete 2,5 m	38 mm	107012		■
Vacuum hose per meter	38 mm	102057		□
<b>Pipes</b>				
Stainless steel pipe (individual)	38 mm	107013		■
<b>Power cord</b>				
Power cord 7,5 m, black		107022	107045	■
<b>Engines</b>				
Engine 1100 W incl. seal		107024		■

■ standard accessories □ optional accessories





## Warning sign

With universally understandable pictogram.  
Robust construction in impact-resistant plastic.  
Foldable, in signal yellow.

	Item-no.
<b>Warning sign symbol (10 pieces)</b>	302015
Safety symbol and colour according ASR A1.3-2013, DIN EN ISO 7010.	



## Single rolling bucket chrome

Bucket volume 27 Litres  
Chrome-plated metal framing with integrated storage basket and push handle. Durable plastic bucket and robust, double-backed mop press.  
LxWxH: 50x41x98 cm

	Item-no.
<b>Single rolling bucket 27 litres chrome</b>	301035



## Double rolling bucket

Bucket volume 2 x 17 Litres  
Durable plastic framing with metal push handle and metal casters. Two colour-coded buckets and robust, double-backed mop press.  
\*Illustrated storage basket is available separately.  
LxWxH: 83x45x88 cm

	Item-no.
<b>Double rolling bucket 2 x 17 litres plastic</b>	301001
<b>Storage basket for 301001</b>	301007



## Double rolling bucket chrome

Bucket volume 2 x 27 Litres  
Stable, chrome-plated metal framing. Rubber wheels with metal casters and four bumper disks. Two colour-coded buckets and robust, double-backed mop press.  
LxWxH: 93x45x82 cm

	Item-no.
<b>Double rolling bucket 2 x 27 litres chrome</b>	301114



## Double rolling bucket chrome pro

Bucket volume 2 x 17 Litres  
Stable, chrome-plated metal framing. Push handle has an integrated fastener for trash bags and a spacious storage basket. Rubber wheels with metal casters and four bumper disks. Two colour-coded buckets and a robust, double-backed mop press.  
LxWxH: 93x39x98 cm.

	Item-no.
<b>Double rolling bucket 2 x 17 litres chrome</b>	301081





# CombiX

Extendable system cart in four variations. Practically orientated solutions in professional quality with sturdy mop press and rubber casters.



① CombiX MINI

② CombiX



③ CombiX XL

④ CombiX PRO

Item-no.

① **COMBIX MINI** rolling bucket 301216  
1 x 35 litres bucket with handle in blue, modular separation wall for optional use as single or double rolling bucket.

② **COMBIX** double rolling bucket 301169  
2 x 25 litres bucket with handle in red + blue, plastic cart with push bar, mop press and side mop shelf

③ **COMBIX XL** system cart 301170  
25 litres bucket with in red, 18 litres bucket with handle in blue, 2 x 6 litres bucket with handle in red + blue, holder for waste bag, mop press and side mop shelf

④ **COMBIX PRO** system cart 301172  
like XL + bucket set 2 x 6 litres yellow + green with tray

**COMBIX, XL, PRO Standard kit:**

Mop press CombiX, XL, PRO	301174
25 litres bucket with handle in red CombiX, XL, PRO	301187
25 litres bucket with handle in blue CombiX	301186
18 litres bucket with handle in blue XL, PRO	301185
6 litres bucket with handle in blue PRO	305024
6 litres bucket with handle in red PRO	305025
6 litres bucket with handle in yellow PRO	305026
6 litres bucket with handle in green PRO	305027
70-litre laundry/rubbish bag	301175
Bucket set 2 x 6 litres green + yellow with tray for CombiX, XL, PRO	301171
Cover for bucket 301176 and 301179	301206

**COMBIX XL + PRO ACCESSORIES:**

Waste separation for Combi XL + PRO	301200
-------------------------------------	--------

ROLLING BUCKETS

Standard storage shelf for the cleaning plan.



**Optional:** Waste separation for CombiX XL/PRO. Item-no. 301200

Ideal positioning of the buckets at ergonomic working height.

**SPRINTUS**  
*COMBIX pro*

Durable, high-quality mop press.

**Upgrade for CombiX and CombiX XL**



Bucket set 2 x 6 litre green + yellow with tray. Item-no. 301171

**Replacement bucket for XL & PRO**



6 Litres blue. Item-no. 305024  
6 Litres red. Item-no. 305025  
6 Litres yellow. Item-no. 305026  
6 Litres green. Item-no. 305027

**Replacement bucket for**



**CombiX**  
25 Litres red. Item-no. 301187  
25 Litres blue. Item-no. 301186

**CombiX XL, PRO**  
25 Litres red. Item-no. 301187  
18 Litres blue. Item-no. 301185

Side tray with 2 x 6 litre closable buckets. Optional for CombiX and CombiX XL, as standard for PRO. Item-no. 301171

Non-transparent 70-litre waste bag.

Extra large 100 mm rubber casters with bumper.

*COMBIX MINI*







**TIP**  
**Starter-sets**  
 contains the following:  
 1 x PuriX  
 1 x Dry vacuum Cleaner Floory  
 1 x Magic Click mopholder  
 1 x Telescopic handle  
 10 x Premium Mop white/blue  
 1 x Warning sign  
 + Waste separation  
 + Storage tray 4-chamber Set

\* Picture shows complete Starter Set.

# PuriX

For hallway, bedroom and bathroom cleaning in public facilities, hotels, guesthouses, hospitals and nursing care. Colour-coded floor buckets, mounting for laundry or waste bags.

The PuriX in professional-graded quality consists in two robust plastic floor plates, the rear plate can be removed if necessary. The stable swivel casters and rubber-coated wheels are perfect for the requirements of daily, hard use. The lid on the laundry or waste bag can be conveniently operated from the ergonomic push handle. Mop or broom can be securely fixed in the built-in clip holder.

Integrated to the frame is a separate hanger for the warning sign. As standard, the PuriX is equipped with four buckets, a lateral mopdeposit, spacious 120 litres laundry / waste bag and a double bracket mop wringer. **TIP** also a Medusa battery sweeper can be carried along on the cleaning trolley.



Warning sign holder, the warning sign can be stored directly on the service cart.



Very easy to take out laundry or waste by using the zipper.



Side shelf for e.g. Medusa.

**Optional accessories:**



Storage tray 3-chamber set.  
 Item-no. 301197



Storage tray 4-chamber set.  
 Item-no. 301198



Robust metal wringer.  
 Item-no. 301003



**Features**

- Compact dimensions
- Rubber coated metal swivel casters
- Large rubber coated back-wheels
- Ergonomically designed push-handle
- Collapsible and space-saving
- Colour coded buckets in 4 and 17 litres
- Storage slot with handle-holder for brooms, mop or the Medusa battery-sweeper
- Spacious storage trays
- 120 litres laundry- / waste bag
- Optional waste separation 2 x 60 litres available



**Accessories:** Optional waste separation.  
 Item-no. 301119

**TIP**  
 Standard in the complete set 301133, and Starter set 013032 & 013033.

TECHNICAL DATA	
Measurements	128 x 50 x 96 cm
Weight	18,1 kg

	Item-no.
<b>PURIX</b> 4 x 4 litres buckets with handle in red, blue, green and yellow 2 x 17 litres buckets with handle in red and blue mop-press, sidestorage for broom or mop laundry- / waste bag with zipper	301106
<b>PURIX complete set</b> Service cart 301106 + waste separation 301119	301133
<b>STARTER SET 40 CM</b> <b>STARTER SET 50 CM</b> Starter sets include the following items: 1 x PuriX, 1 x Dry vacuum cleaner Floory 1 x Magic Click mopholder, 1 x Telescopic handle, 1 x Warning sign, 10 x Premium Mop white/blue, + Waste separation + Storage tray 4-chamber Set	013032 013033
<b>STANDARD KIT:</b> 4 litres bucket with handle in red 4 litres bucket with handle in yellow 4 litres bucket with handle in blue 4 litres bucket with handle in green 17 litres bucket with handle in red 17 litres bucket with handle in blue Laundry- / waste bag (with zipper)	301101 301102 301103 301104 301316 301317 301115
<b>ACCESSORIES:</b> Waste separation for service cart Mop storage for service cart Storage tray 3-chamber Set Storage tray 4-chamber Set Warning sign Symbol (10 pieces) mop-press	301119 301126 301197 301198 302015 301003



# PuriX PRO

Lockable cleaning trolley for versatile use.



The compact, robust PuriX PRO cleaning trolley is particularly impressive with its lockable doors. This makes it suitable not only for cleaning corridors, rooms and bathrooms in public facilities, offices or hotels, but also guarantees maximum safety in the healthcare sector.

The two lockable storage compartments provide sufficient storage space for cleaning agents and other utensils. The optional storage trays ensure order behind the doors. In addition, the PuriX PRO is equipped with a holder for a laundry/waste bag.

The latter rests on a storage tray, which is reinforced by an additional wheel and can be removed if required. The cleaning trolley accommodates four large 5-liter buckets, which feature 4-color coding.

The PuriX PRO is also equipped with two 17 liter buckets and a metal wringer. Sturdy metal swivel casters and large, rubberized rear wheels give the cleaning trolley stability and allow for easy, safe maneuvering around the facility.

## Optional accessories:



Storage tray 4-chamber set.  
Item-no. 301198



Storage tray 3-chamber set.  
Item-no. 301197

## Standard accessories:



Robust metal wringer.  
Item-no. 301003

## Features

- Side mop shelf
- Warning sign holder
- Robust metal wringer
- Compact dimensions
- Rubber coated metal swivel casters
- Large rubber coated back-wheels
- Ergonomically designed push handle
- Colour coded buckets in 4 and 17 litres
- Spacious storage area
- 120 litres laundry /waste bag
- Optional waste separation 2 x 60 liters available



Very easy to take out laundry or waste by using the zipper.

## PURIX PRO

Item no. 301500

4 x 4 liter bucket with handle in red, blue, green and yellow, 2 x 17 liter buckets with handle in red and blue, mop press, side storage for mop or broom or broom, laundry - / waste bag with zipper.

STANDARD ACCESSORIES:	
5 liter bucket with handle in blue	304013
5 liter bucket with handle in red	304014
5 liter bucket with handle in green	304015
5 liter bucket with handle in yellow	304016
17 liter bucket with handle in red	301316
17 liter bucket with handle in blue	301317
Laundry / waste bag with zipper	301115
Robust metal wringer	301003

OPTIONAL ACCESSORIES:	
Mop tray for PuriX	301126
Storage tray 3-chamber set	301197
Storage tray 4-chamber set	301198
Warning sign symbol (10 pieces)	302015
Warning sign "danger of slipping" (10 pieces)	301034
Waste separation for PuriX Pro	301521

## TECHNICAL DATA

Dimensions	134 x 60 x 110 cm
Weight	30,3 kg



The optional storage trays with three or four chambers ensure order behind the doors. This means that the storage space can be optimally utilised for cleaning agents and other utensils.



# MatriX

Lockable cleaning trolley in two versions.

The MatriX, optionally with mop press or mop boxes, impresses with perfect workmanship, an extremely solid and robust construction, as well as an excellent price-performance ratio. The extra-large interior has three pull-out trays and a storage grid and offers versatile storage space for cleaning agents or other utensils. The lockable door ensures maximum security in the property and guarantees a modern and discreet appearance at all times. Thanks to the large rubberised 100 mm swivel castors, the MatriX can be moved effortlessly and safely at all times, even when fully loaded. The rear swivel castors have two individually lockable parking brakes and secure the MatriX against unintentional rolling away when parked.



## Supply



Maximum load volume. Extensive basic equipment.



4-colour coding throughout.



Lockable doors provide security.

### Optional accessories:



6-litre bucket with transparent lid.

## Disposal



Laundry or waste can easily be removed using a zipper.



65 litre capacity.



Practical support surface and storage for cleaning plans.



Optional waste separation. Item-no. 304024



Optional waste bag small. Item-no. 304025

## Cleaning



## Customisation

Design the door of your MatriX according to your ideas. As a travelling advertising medium, it transports your corporate design and your advertising message directly to the customer or visitor.

	Item-no.
<b>MATRIX-PRESS</b>	<b>304001</b>
4 x 5-litre buckets with handle in red, blue, green and yellow	
2 x 17-litre buckets with handle in blue and red	
Mop press, side storage support for mop, laundry / waste bag with zipper	
Three storage trays and one storage grid with a lockable door.	
<b>MATRIX-BOX</b>	<b>304003</b>
4 x 5-litre buckets with handle in red, blue, green and yellow	
2 x mop-box red/blue, side storage support for mop, laundry / waste bag with zipper	
Three storage trays and one storage grid with a lockable door.	
Mop-box, grey, blue handle and lid	301270
Mop-box, grey, red handle and lid	301271
Mop-box set (mounting set for MatriX)	301272
<b>STANDARD KIT:</b>	
5-litre bucket with handle in blue	304013
5-litre bucket with handle in red	304014
5-litre bucket with handle in green	304015
5-litre bucket with handle in yellow	304016
17-litre bucket with handle in red (only with PRESS)	301316
17-litre bucket with handle in blue (only with PRESS)	301317
Laundry / waste bag with zipper	304022
<b>OPTIONAL ACCESSORIES:</b>	
Waste separation 2 x 30 litre	304024
Laundry bag 30 litre	304025
Warning sign symbol (10 pieces)	302015
Warning sign "danger of slipping" (10 pieces)	301034
6 litre bucket with handle in blue + lid	305024
6 litre bucket with handle in red + lid	305025
6 litre bucket with handle in green + lid	305026
6 litre bucket with handle in yellow + lid	305027



Optional soaking aid. Item-no. 305032 blue & 305033 red



Hand free pick-up with optional V-Wing folding holder (p. 114).



# VariX

Expandable, lockable cleaning trolley in four versions.



With a total of four top-quality versions of the closed VariX cleaning trolley, we offer maximum benefits and the highest standards of hygiene for daily use in the healthcare and HoReCa sectors. The modular design is more versatile than ever and enables the right solution for every application. With its smooth and easy-to-clean surfaces as well as closed hygiene casters, buckets and optional mop boxes, it can be used in compliance with the

highest hygiene regulations. The lockable doors ensure maximum safety in the building, and the large pull-out drawers offer tons of loading space. Even at full load, the VariX can be manoeuvred without any great effort, and the extra large 150 mm steering casters overcome obstacles easily.

The VariX series is a reliable partner with an excellent price-performance ratio and a high level of cost-effectiveness.

① VariX  
Item-no. 305001



② VariX - Press  
Item-no. 305002



③ VariX - Box  
Item-no. 305003



④ VariX - Box Compact  
Item-no. 305004



Cleaning

Supply

Disposal

Maximum hygiene with closed buckets and continuous 4-colour coding.

Variable disposal unit.

Extra large, variable supply unit.

VariX - Box

Bracket for up to three warning signs.

Multi-functional tool holder.

Protection from unauthorised access via removable key connectors.

Smooth surfaces throughout that can be hygienically cleaned.

Closed and easy-to-clean, extra large 150 mm steering casters for excellent handling. Front and rear parking brakes.

Bumpers all around for protection in the building.



# Disposal

The disposal unit can be designed variably according to your choice and your requirements.

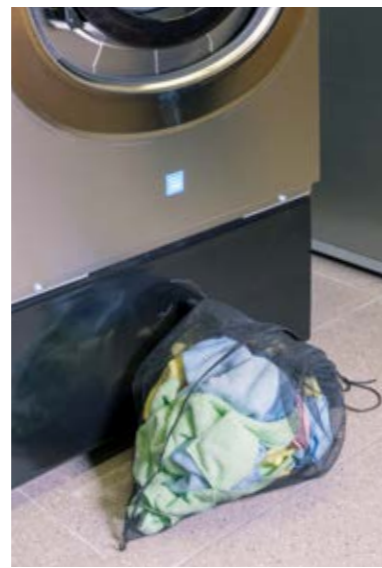

The removable laundry net is 35 litres in size and is ideal for the disposal of used cleaning cloths. The convenient shelf for cleaning schedules is directly in the field of view.

Non-contact removal of the mop covers with the optional mop holder V-Wing (p. 130).



Multi-functional tool holder as standard. Item-no. 305043



Practical warning sign bracket for up to three warning signs.



# Supply

High loading volume and smooth-running trays.



Standard drawers (without accessories).



Deep trays, 18 litres in size, optional. Item-no. 305034





## Supply

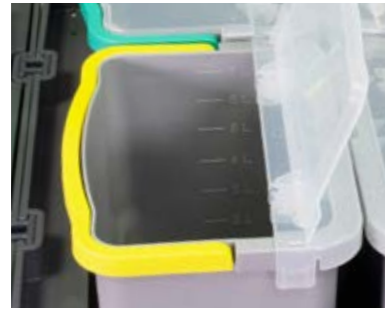

Hygienic, transparent lid that can be placed upright. Buckets with scale indication.



Continuous 4-colour coding. Optimal stability through lowered buckets.



Protection from unauthorised access via removable key connectors.

### Optional accessories:



Hook-in 30 litre buckets. Item-no. 305035

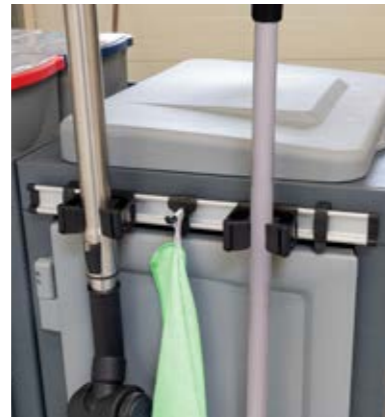

Two additional tool holders can be retrofitted.

## Cleaning



Capacity for 10 pcs. 40 cm mop covers per box.



Optional soaking aid. Item-no. 305032 blue & 305033 red



Hand free pick-up with optional V-Wing folding holder (p. 130).



Transport for up to four mop boxes.

### Your advantages at a glance:

- Pre-assembled delivery on time and directly to the place of your choice.
- Your own brand: customised, large-scale and creative design with your company logo and in your corporate design.
- Customisation even for small quantities and at fair conditions.



## Customisation

Design the doors of your VariX according to your own ideas. As a mobile advertising medium, it will transport your corporate design and your advertising message directly to customers and visitors.



	Item-no.
<b>VARIX</b> Including disposal and supply unit. Does not include a cleaning unit.	305001
<b>VARIX - PRESS</b> Complete set VariX 305001 + mop-press-set 305041 Consisting press and attachment set.	305002
<b>VARIX - BOX</b> Complete set VariX 305001 + mop-box-set 305040 Consisting of blue/red mop box and attachment set.	305003
<b>VARIX - BOX COMPACT</b> Complete set VariX 305001 + mop-box-set 305048 Consisting of blue/red mop box and attachment set.	305004
<b>STANDARD KIT:</b>	
2 x Fastening brackets, 70 litre, blue	305012
2 x Fastening brackets, 70 litre, red	305013
2 x Fastening brackets, 35 litre, blue	305015
2 x Fastening brackets, 35 litre, red	305016
Waste separation for 2 x 35 litre	305014
Laundry net, 35 litre, black	305018
Drawer, flat, grey	305021
Drawer, medium, grey	305022
Hook-in tray, grey	305023
6-litre bucket with a handle in blue + lid	305024
6-litre bucket with a handle in red + lid	305025
6-litre bucket with a handle in green + lid	305026
6-litre bucket with a handle in yellow + lid	305027
Tool holder set	305043
<b>OPTIONAL ACCESSORIES:</b>	
Soaking aid for mop box, blue	305032
Soaking aid for mop box, red	305033
Drawer set, deep, 2 x 18 litre	305034
Hook-in bucket, 30 litre, grey	305035
Laundry bag, grey, with eyelets	305036
Warning sign "danger of slipping" (10 pieces)	301034
Warning sign symbol (10 pieces)	302015



# Magic Click

Ingeniously simple – simply ingenious! Foldable magnetic mop holder with patented self-standing function.

A smart solution with a big impact! Simply leave the Magic Click standing anywhere in the room when you need both hands free. The robust cardan joint can be pivoted all the way round for the figure 8 mopping technique and can be locked at any time so that the Magic Click can be left standing immediately and in any place. No need to lean it against the wall or an object. Goodbye to endless bending over to pick up the fallen mop. With Magic Click, you work effectively, quickly and consistently protect your back.

Magnetic-mop holder (VE 10 pieces)		Item-no.
<b>MAGIC CLICK</b> 40 cm		301039
<b>MAGIC CLICK</b> 50 cm		301040
<b>ACCESSORIES:</b>		
Aluminium handle	1,40 m	301018
Telescopic handle	0,80 - 1,45 m	301037
Telescopic handle PRO	0,96 - 1,75 m	301224
Spray handle		301218



Ergonomic, ribbed grip for secure holding, even through gloves.

**Accessories:** telescopic handle, height-adjustable in range 0.80 - 1.45 m for setting to the optimum working height. (Handle is not part of delivery content.)



Optional telescopic handle with Quick-action locking for simple height adjustment.

Shaft and holder are securely fixed with a stainless steel screw.

The click-action lock of the reliable self-standing function has been tested in a 10,000 action cycle.

All pivoting pins and screws are made of stainless steel.

The easy action redary joint enables easy turning in any direction and at any angle.



Strong magnetic catch with 5 kg closing force and automatic locking. The holder opens asymmetrically, thus facilitating threading into the mop pockets.

Optionally in 40 or 50 cm working width.

The snap-action holder can be easily opened with the large 2-stage foot switch.

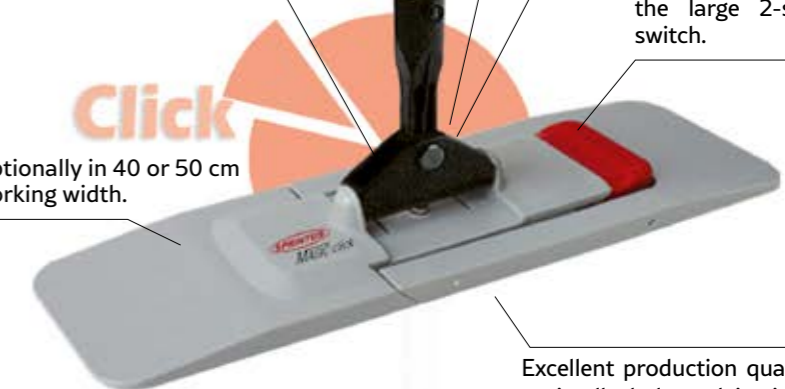

Excellent production quality and an optimally balanced intrinsic weight guarantee perfect mopping action and strain-free working.





## Spray handle

Ideal for small objects.  
Filling quantity approx. 550 ml.

<b>Spray handle</b>	Item-no.
(20 pieces)	301218



## ECO foldable mop holder

Foldable mop holder without self-standing function.  
Easy to handle very sturdy mop holder. In two sizes, 40 cm or 50 cm wide.

<b>Foldable mop holder</b> (10 pieces)	Item-no.
ECO 40 x 10 cm (without upright function)	301249
ECO 50 x 11,5cm (without upright function)	301250

## ECO PRO foldable mop holder

Foldable magnetic mop holder without self-standing function.  
Easy to handle very sturdy magnetic mop holder. In two sizes, 40 cm or 50 cm wide.

<b>Foldable magnetic mop holder</b> (10 pieces)	Item-no.
ECO 40 x 10 cm (without upright function)	301041
ECO 50 x 11,5cm (without upright function)	301042

## V-Wing mop holder

Mop holder with innovative spread position.

<b>V-Wing mop holder</b> (10 pieces)	Item-no.
V-40 40 x 10,5 cm (without upright function)	301143
V-50 50 x 12,0 cm (without upright function)	301144

## Aluminium handle

with black handle.

## Telescopic handle

made of high-strength aluminium

Spray handle PRO Standard

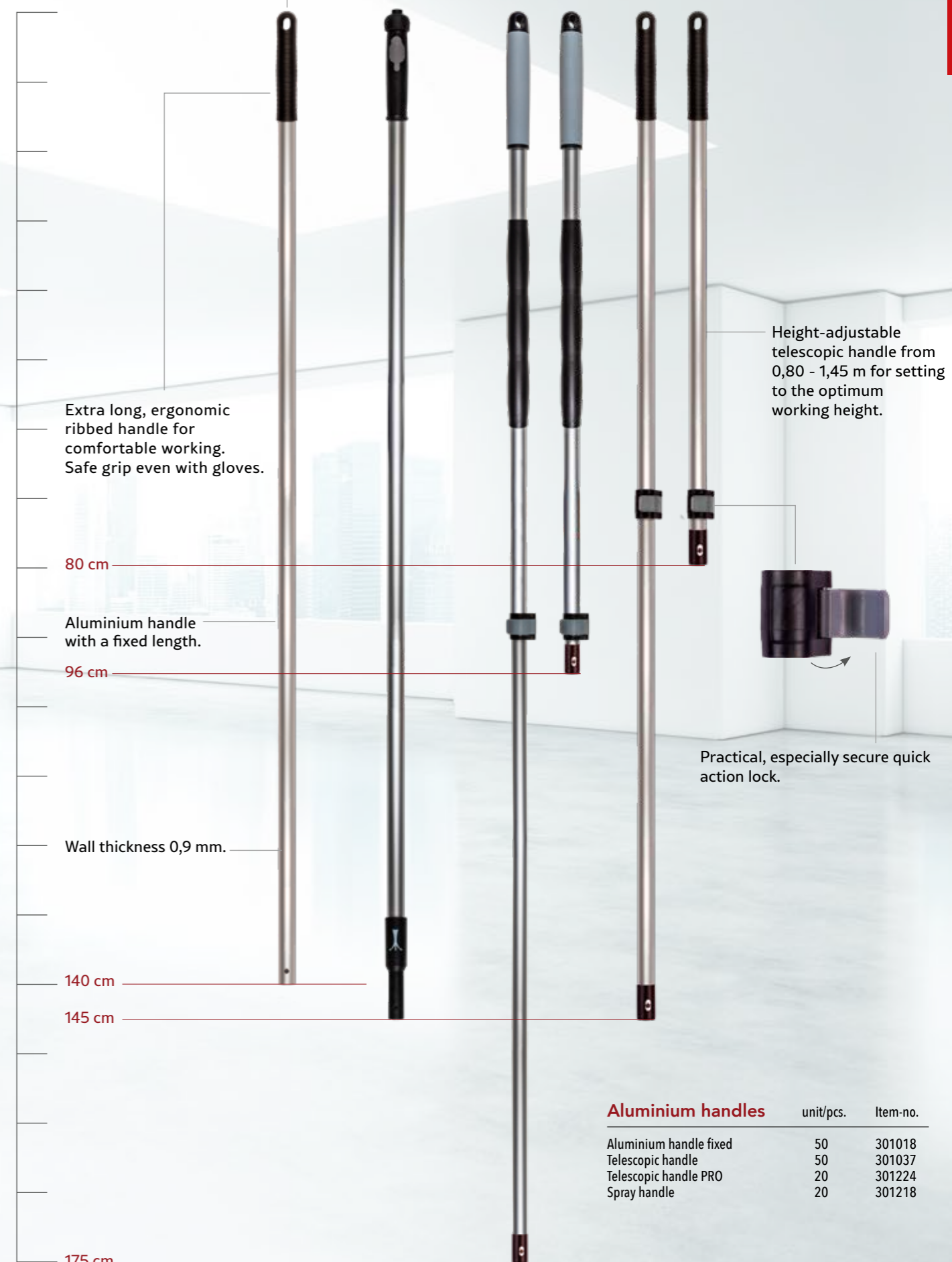

Extra long, ergonomic ribbed handle for comfortable working. Safe grip even with gloves.

Height-adjustable telescopic handle from 0,80 - 1,45 m for setting to the optimum working height.

80 cm

Aluminium handle with a fixed length.

96 cm

Practical, especially secure quick action lock.

Wall thickness 0,9 mm.

140 cm

145 cm

175 cm

Aluminium handles	unit/pcs.	Item-no.
Aluminium handle fixed	50	301018
Telescopic handle	50	301037
Telescopic handle PRO	20	301224
Spray handle	20	301218





# Our mop covers for efficient cleaning.

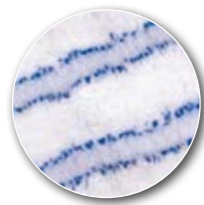

**Maximum quality.**  
We process only selected materials of the highest quality. In doing so, we focus on top performance with maximum durability and service life.



**Four-colour coding.**  
Our mop covers have a four-colour coding (red, green, blue, yellow). To mark a cover, the flags that are not needed are simply cut off.



**Tear-resistant, padded pocket material.**  
Thanks to the padded pocket material, the covers can be installed easily with the mop holder. The water can drain off perfectly through the durable and robust pocket material. The pocket material is manufactured according to our high requirements and undergoes regular testing procedures.



**Embroidered care instructions.**  
On a label embroidered directly on the cover, important care instructions are inherently stable and permanently visible.



**Your customer logo.**  
Increase your brand recognition and have your mop covers individually printed with your logo, already upon the purchase of a single box.

**Tip**

Properly washing and preparing mop covers is of great importance for their durability. We have summarised our professional tips in a care manual for you.



## The right mop cover for your floor.

Different floor coverings and cleaning tasks require different mop covers. We offer you the right product solution for every floor covering and degree of soiling.

	Elastic floor coverings					Natural and artificial stone floor coverings					Wood / laminate surfaces			
	PVC	Vinyl designer coverings	Linoleum	PU / rubber	Marbel	Tiles	Safety tiles	Fine stoneware	Granite	Laminate	Parquet, oiled	Parquet, sealed	Parquet, waxed	Disinfectant resistant
<b>Cotton mop</b>														
Classic	●	●	●	○	○	○	○	○	○	-	▲	▲	▲	-
Classic PRO														
<b>Microfiber mop</b>														
Basic	●	●	●	●	●	●	○	○	●	▲	○	▲	▲	-
Basic PRO														
Delphin	●	●	●	●	●	●	○	○	●	▲	○	▲	▲	-
Premium	●	●	●	●	●	●	●	●	●	▲	○	▲	▲	-
Premium PRO														
Shark RED	●	●	●	●	●	●	●	●	●	▲	○	▲	▲	-
Bluestar	●	●	●	●	●	●	○	○	●	▲	○	▲	▲	●
Medic	●	●	●	●	●	●	○	○	●	▲	○	▲	▲	●
<b>Mixed-fabric mop</b>														
Excellent	●	●	●	●	●	●	○	○	●	▲	○	▲	▲	●
<b>Chenille mop</b>														
Octopus blue/red	●	●	●	●	●	●	○	○	●	▲	○	▲	▲	-

● recommended   ▲ damp wipe   ○ not optimal for this material   - unsuitable for this material

You will find these washing and care instructions on the following pages. We recommend that you follow them for a maximum working life of the mop covers.



Washing up to max. 95°



Drying in gentle program at low temperature



Not suitable for drier



Bleaching not recommended



Ironing not recommended

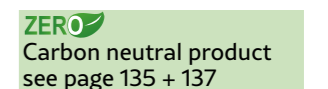



## Basic

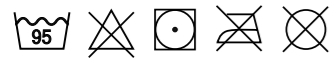

Microfiber mop	
Colour	white
Material	100 % polyester
Width	40 and 50 cm
Weight	approx. 80 gr. in 40 cm width approx. 105 gr. in 50 cm width
Properties	<ul style="list-style-type: none"> <li>• Standard cover</li> <li>• Good running characteristics</li> <li>• Tear-resistant and water-permeable pockets</li> </ul>

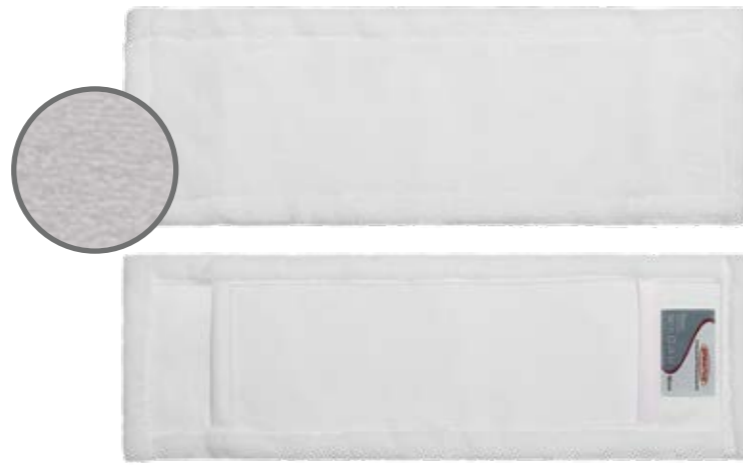

Basic	Item-no.
Microfiber mop 40 cm, white (75 pieces/unit)	301230
Microfiber mop 50 cm, white (50 pieces/unit)	301231

## Basic PRO

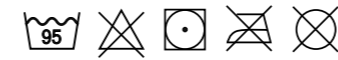

Professional mop made of microfiber	
Colour	white
Material	100 % polyester
Width	40 and 50 cm
Weight	approx. 90 gr. in 40 cm width approx. 120 gr. in 50 cm width
Properties	<ul style="list-style-type: none"> <li>• Top-quality finish</li> <li>• High grammage</li> <li>• Four-colour coding</li> <li>• Extra tear-resistant, padded and water-permeable bags</li> </ul>

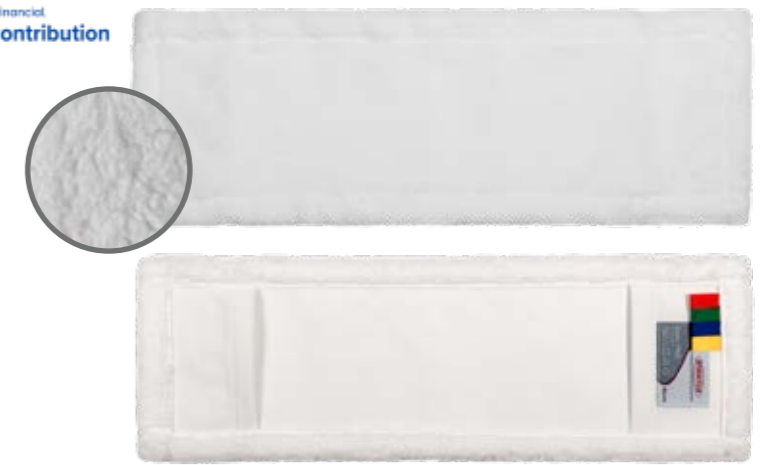

Basic PRO	Item-no.	ZERO
Microfiber mop 40 cm, white (75 pieces/unit)	301019	Z301019
Microfiber mop 50 cm, white (50 pieces/unit)	301020	Z301020

## Premium



Microfiber mop	
Colour	white/blue
Material	81 % polyester 19 % polyamid (soft bristles)
Width	40 and 50 cm
Weight	approx. 80 gr. in 40 cm width approx. 105 gr. in 50 cm width
Properties	<ul style="list-style-type: none"> <li>• Standard cover</li> <li>• Good running characteristics</li> <li>• Tear-resistant and water-permeable pockets</li> <li>• Scrubbing effect via blue bristles</li> </ul>

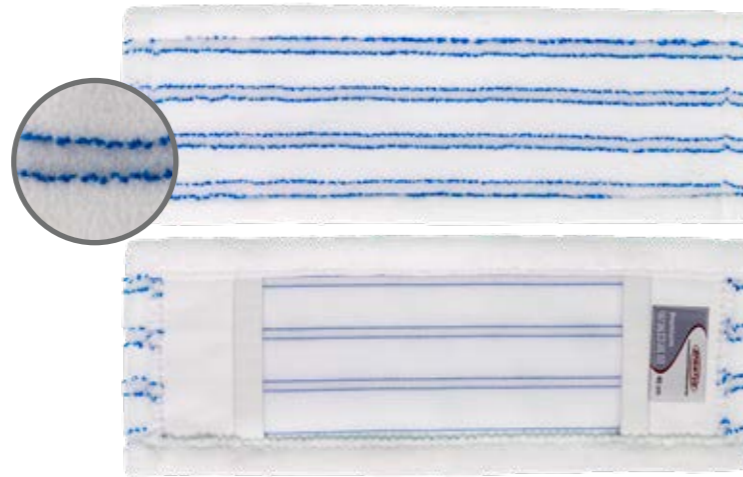

Premium	Item-no.
Microfiber mop 40 cm, white/blue (75 pieces/unit)	301232
Microfiber mop 50 cm, white/blue (50 pieces/unit)	301233

## Premium PRO



Professional mop made of microfiber	
Colour	white/blue
Material	81 % polyester 19 % polyamid (soft bristles)
Width	40 and 50 cm
Weight	approx. 90 gr. in 40 cm width approx. 120 gr. in 50 cm width
Properties	<ul style="list-style-type: none"> <li>• Top-quality finish</li> <li>• High grammage</li> <li>• Four-colour coding</li> <li>• Extra tear-resistant, padded and water-permeable bags</li> <li>• Scrubbing effect via blue bristles</li> </ul>

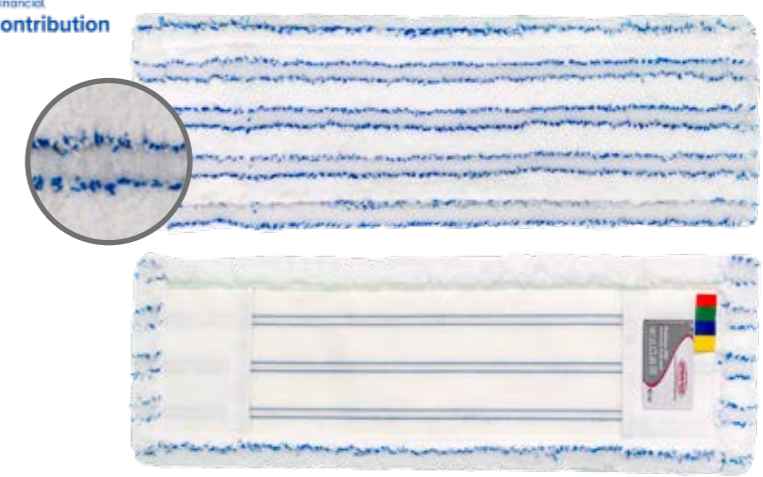

Premium PRO	Item-no.	ZERO
Microfiber mop 40 cm, white/blue (75 pieces/unit)	301021	Z301021
Microfiber mop 50 cm, white/blue (50 pieces/unit)	301022	Z301022

## Classic

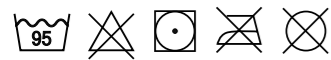

Cotton mop	
Colour	beige
Material	70 % precious cotton 30 % polyester
Width	40 and 50 cm
Weight	approx. 120 gr. in 40 cm width approx. 160 gr. in 50 cm width
Properties	<ul style="list-style-type: none"> <li>• Standard cover</li> <li>• High level of cotton content</li> <li>• Four-colour coding</li> <li>• Water-permeable bags</li> </ul>



Classic	Item-no.
Cotton mop 40 cm, with 4-colour system (75 pieces/unit)	302037
Cotton mop 50 cm, with 4-colour system (50 pieces/unit)	302038

## Classic PRO



Professional mop made of cotton	
Colour	beige
Material	70 % precious cotton 30 % polyester
Width	40 and 50 cm
Weight	approx. 160 gr. in 40 cm width approx. 220 gr. in 50 cm width
Properties	<ul style="list-style-type: none"> <li>• Top-quality finish</li> <li>• Extra high density and weight</li> <li>• Tuft mop with extra tear-resistant, padded and water-permeable bags</li> <li>• Four-colour coding</li> </ul>



Classic PRO	Item-no.	ZERO
Cotton mop 40 cm, with 4-colour system (75 pieces/unit)	301048	Z301048
Cotton mop 50 cm, with 4-colour system (50 pieces/unit)	301049	Z301049

The right mop cover for your floor? See table on page 133.

The right mop cover for your floor? See table on page 133.



# Bluestar



Professional mop made of microfiber	
Colour	white/blue
Material	100 % polyester
Width	40 and 50 cm
Weight	approx. 160 gr. in 40 cm width approx. 200 gr. in 50 cm width
Properties	<ul style="list-style-type: none"> <li>• Top-quality finish</li> <li>• Extremely high level of grammage and perfect water absorption</li> <li>• The shape and colour are retained even after many washes.</li> <li>• Four-colour coding</li> <li>• Padded and water-permeable bag</li> <li>• Guarantees even absorption of dirt</li> <li>• Disinfectant-resistant</li> </ul>



Bluestar	Item-no.
Microfiber mop 40 cm, white/blue (75 pieces/unit)	301227
Microfiber mop 50 cm, white/blue (50 pieces/unit)	301228

# Excellent



Professional mop made of cotton und microfiber	
Colour	white/blue
Material	50 % cotton, 40 % polyester 10 % acryl
Width	40 and 50 cm
Weight	approx. 160 gr. in 40 cm width approx. 230 gr. in 50 cm width
Properties	<ul style="list-style-type: none"> <li>• Water-permeable bags</li> <li>• Four-colour coding</li> <li>• Firm anchoring of the loops in the cover sheet due to the special tufting process</li> <li>• Very good water and dirt absorption for optimum gliding properties</li> <li>• Long service life, even when disinfectant is used</li> <li>• Fringe closed on the inside and open on the outside</li> </ul>



Excellent	Item-no.	ZERO
Mixed Microfiber mop 40 cm, white/blue (75 pieces/unit)	302010	Z302010
Mixed Microfiber mop 50 cm, white/blue (50 pieces/unit)	302011	Z302011

# Delphin

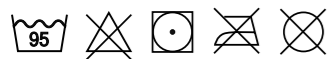

Professional mop made of microfiber	
Colour	white/grey
Material	100 % polyester
Width	40 and 50 cm
Weight	approx. 85 gr. in 40 cm width approx. 105 gr. in 50 cm width
Properties	<ul style="list-style-type: none"> <li>• Grey fibres make the cover look like new after use and after washing</li> <li>• Outstanding finish</li> <li>• Extra tear-resistant, padded and water-permeable bags</li> <li>• Four-colour coding</li> </ul>

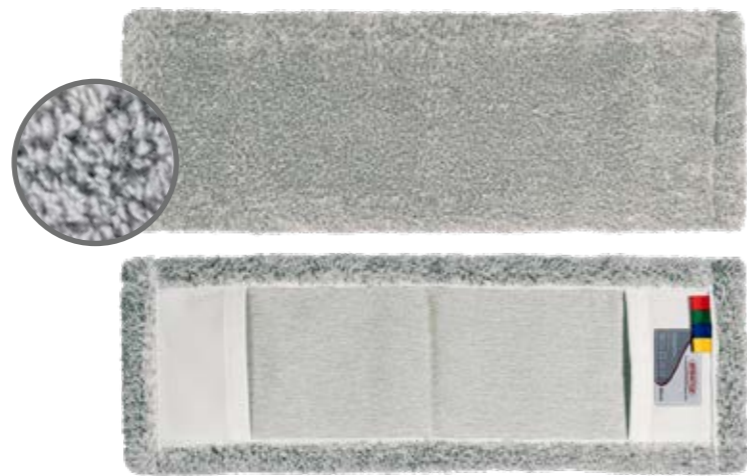

Delphin	Item-no.
Microfiber mop 40 cm, white/grey (75 pieces/unit)	301225
Microfiber mop 50 cm, white/grey (50 pieces/unit)	301226

# Shark RED



Professional mop made of microfiber	
Colour	white/red
Material	100 % polyester
Width	40 and 50 cm
Weight	approx. 90 gr. in 40 cm width approx. 120 gr. in 50 cm width
Properties	<ul style="list-style-type: none"> <li>• Optimum dirt-removing power due to extra strong polyamide bristle strips</li> <li>• High scrubbing action to remove dirt and stains</li> <li>• Ideal for removing stubborn dirt</li> <li>• Suitable for wet cleaning of highly structured and rough floor coverings</li> <li>• Excellent gliding properties for fatigue-free work</li> <li>• 4-colour coding</li> </ul>



Shark RED	Item-no.
Microfiber mop 40 cm, white/red (75 pieces/unit)	302093
Microfiber mop 50 cm, white/red (50 pieces/unit)	302094

# Octopus blue / red

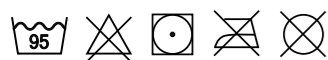

Chenille mop made of microfiber	
Colour	red/blue
Material	100 % polyester
Width	40 and 50 cm
Weight	approx. 160 gr. in 40 cm width approx. 200 gr. in 50 cm width
Properties	<ul style="list-style-type: none"> <li>• Particularly soft and fine chenille surface, a special fabric made from chenille yarn.</li> <li>• Uniform wiping result</li> <li>• Excellent washability, i.e. enormous savings in piece numbers used and washing costs (up to 50% compared to other mops)</li> </ul>



Octopus blue / red	Item-no.
Chenille mop 40 cm blue (75 pieces/unit)	302012
Chenille mop 50 cm blue (50 pieces/unit)	302013
Chenille mop 40 cm red (75 pieces/unit)	302035
Chenille mop 50 cm red (50 pieces/unit)	302036

# Medic



Disinfectant-resistant microfiber mop	
Colour	white
Material	80 % polyester, 20 % nylon
Width	40 and 50 cm
Weight	approx. 90 gr. in 40 cm width approx. 120 gr. in 50 cm width
Properties	<ul style="list-style-type: none"> <li>• Very resistant due to reinforced cover material and seams</li> <li>• Ideal for dry and thermal cleaning</li> <li>• Maximum durability when exposed to disinfectants</li> <li>• 4-colour coding</li> <li>• Particularly suitable for the healthcare sector</li> </ul>

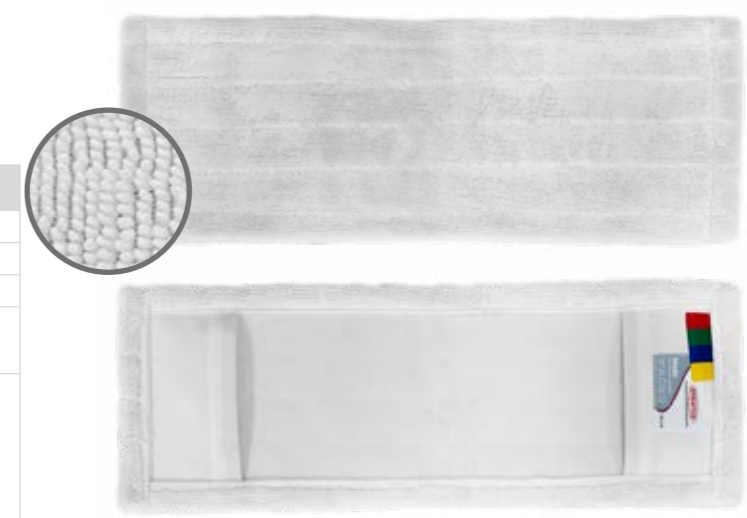

Medic	Item-no.
Microfiber mop 40 cm, with 4-colour system (75 pieces/unit)	302095
Microfiber mop 50 cm, with 4-colour system (50 pieces/unit)	302096



# Pocket and flap mops

## Premium PRO pocket and flap mops

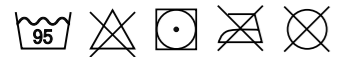

### Professional mop made of microfiber

Colour	white/blue
Material	81 % polyester 19 % polyamid (soft bristles)
Width	40 and 50 cm
Weight	approx. 90 gr. in 40 cm width approx. 120 gr. in 50 cm width
Properties	<ul style="list-style-type: none"> <li>• Top quality processing</li> <li>• High grammage</li> <li>• 4-colour coding</li> <li>• Extra tear-resistant, padded and water-permeable pockets</li> <li>• Scrubbing effect due to blue bristles</li> <li>• Lightweight</li> </ul>

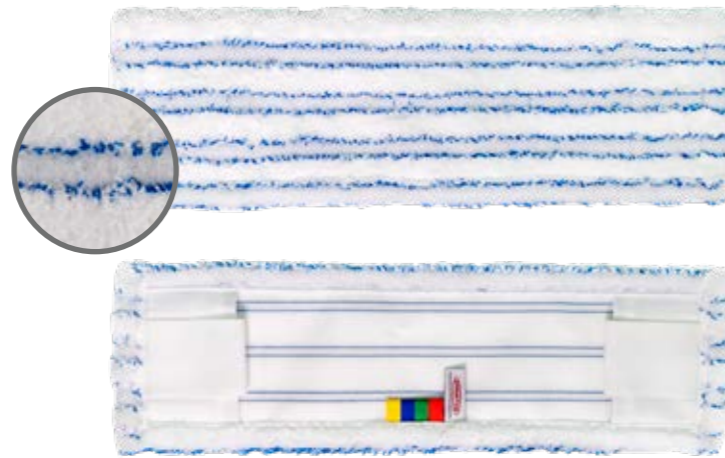

### Premium PRO with pocket and flap mops

	Item-no.
Microfiber mop 40 cm, white/blue (75 pieces/unit)	301361
Microfiber mop 50 cm, white/blue (50 pieces/unit)	301362

## Classic PRO pocket and flap mops

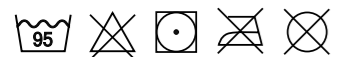

### Professional mop made of cotton

Colour	beige
Material	70 % precious cotton 30 % polyester
Width	40 and 50 cm
Weight	approx. 160 gr. in 40 cm width approx. 220 gr. in 50 cm width
Properties	<ul style="list-style-type: none"> <li>• Top quality</li> <li>• Extra high density and weight</li> <li>• Tufted mop with extra tear resistant, water permeable and padded pockets</li> <li>• 4-colour coding</li> </ul>



### Classic PRO with pocket and flap mops

	Item-no.
Cotton mop 40 cm, with 4-colour system (75 pieces/unit)	302098
Cotton mop 50 cm, with 4-colour system (50 pieces/unit)	302099

We offer you two models of our traditional pocket mops as a combination of pocket and flap mop. This applies to the Premium PRO professional mop made of microfiber and the Classic PRO made of cotton. They combine the advantages of pure pocket mops and flap mops. If the mop cover is used as a pocket mop, it may be attached with ease with the mop holder during operation and in an upright position. As a flap mop, on the other hand, the user benefits from the fact that the mop cover is always held securely in position by the tension flaps. This permits contact-free wringing out of the mop.

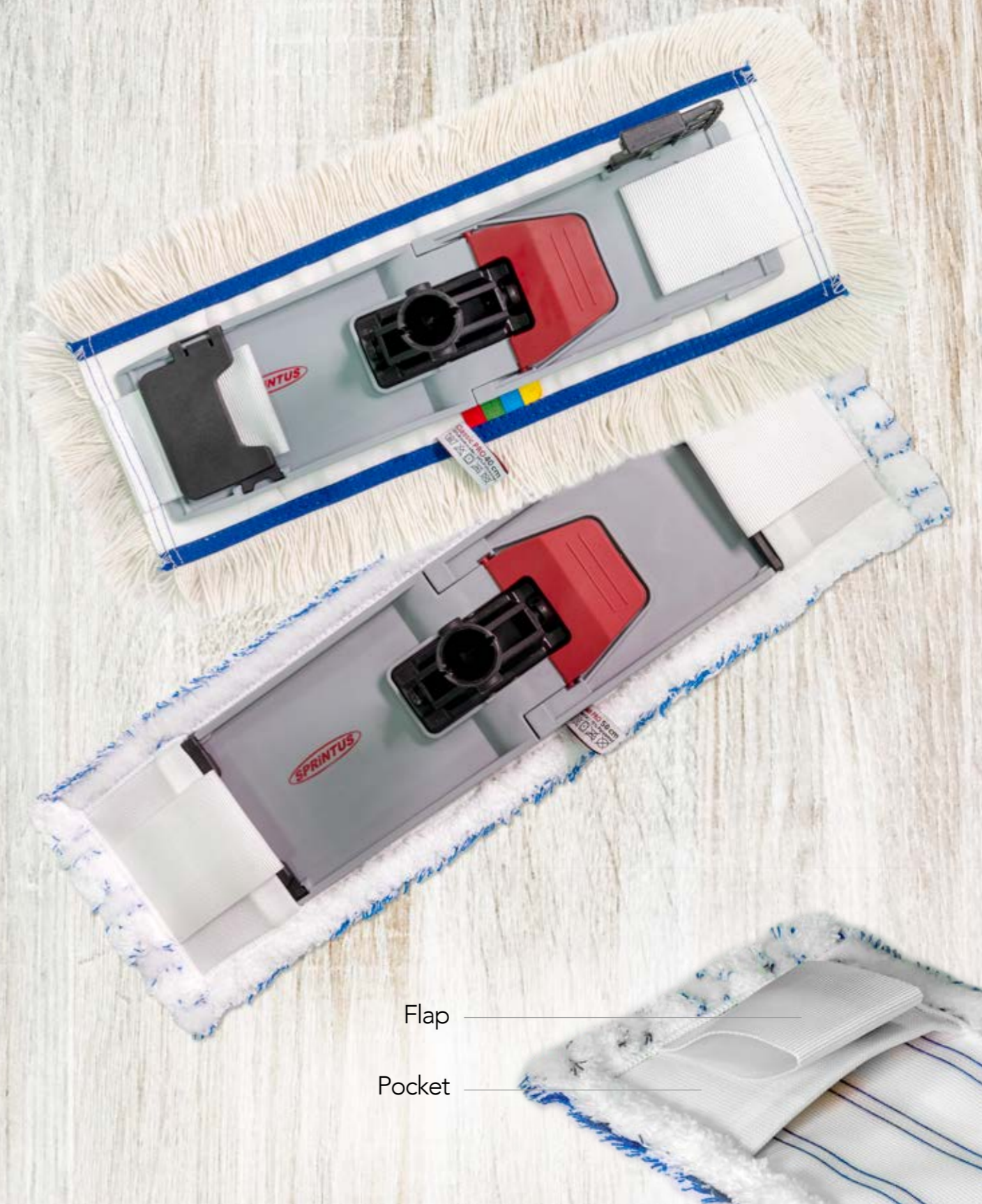

Flap

Pocket



# MICROFIBER CLOTH

## "RAINBOW"

Universal cleaning cloth for wet and dry application with high water absorption. Guaranteed lint- and streak-free.

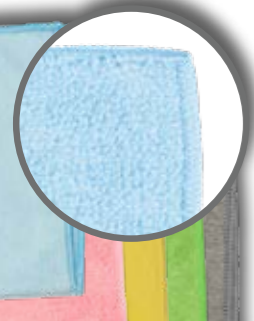

Rainbow microfiber cloth

Colour: red, blue, yellow, green, grey  
 Yarn blend: 80 % polyester  
 20 % polyamide  
 Width: 40 x 40 cm  
 Weight: 260 g/m<sup>2</sup>

<b>blue</b>	Item-no.
Microfiber cloth 40 cm blue (5 pieces)	301235
<b>red</b>	Item-no.
Microfiber cloth 40 cm red (5 pieces)	301236
<b>yellow</b>	Item-no.
Microfiber cloth 40 cm yellow (5 pieces)	301237
<b>green</b>	Item-no.
Microfiber cloth 40 cm green (5 pieces)	301238
<b>grey</b>	Item-no.
Microfiber cloth 40 cm grey (5 pieces)	301363

# MICROFIBER CLOTH

## "RAINBOW PRO"

High-performance cloth for different surfaces. The coarse structure can be used for universal dry and wet applications on all common surfaces. The fine surface for fine grinding and streak-free, scratch-free polishing of sensitive surfaces.



Rainbow microfiber cloth PRO

Colour: red, blue, yellow, green, grey  
 Yarn blend: 80 % polyester  
 20 % polyamide  
 Width: 40 x 40 cm  
 Weight: 340 g/m<sup>2</sup>

<b>PRO blue</b>	Item-no.
Microfiber cloth 40 cm blue (5 pieces)	301240
<b>PRO red</b>	Item-no.
Microfiber cloth 40 cm red (5 pieces)	301241
<b>PRO yellow</b>	Item-no.
Microfiber cloth 40 cm yellow (5 pieces)	301242
<b>PRO green</b>	Item-no.
Microfiber cloth 40 cm green (5 pieces)	301243
<b>PRO grey</b>	Item-no.
Microfiber cloth 40 cm grey (5 pieces)	301364



Kitchen area / hospital room



Surfaces



Toilet/urinal



Gastronomy

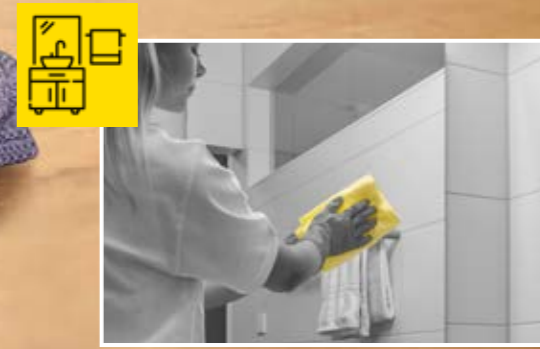

Sanitary area



# Your brand.

Increase your brand recognition and focus on individualization in your corporate design.

Dry vacuum cleaners: ERA EVO + ERA TEC + ERA iGO

From 10 pieces\* with your logo.



FREE: Your logo on the digital touch display



ERA PRO

Customisation with your logo via the free SPRINTUS APP in seconds.



### Mops with logo print

You can choose from all SPRINTUS microfiber and cotton covers (except flap covers) on pages 134 -137 and have them individually printed with your logo for orders of one box\* or more. In this special printing process, your company logo is integrated directly into the fibers and is scratch- and wash-resistant.

Best of all: you will receive the goods within just a few working days.

### Custom order - custom made including embroidered labels.

If you cannot find what you are looking for in our range, please contact us. We have a large selection of materials, which we can customise and produce to suit the respective area of application and your individual requirements. In addition, we can offer any type and special size on request, as well as colour changes and coding that meet your requirements and areas of application.

From 1 carton\* already with high-quality logo print.

\*40 cm = 75 pieces per box, 50 cm = 50 pieces per box

### Video mop printing



In larger quantities in your colour including user manual, packaging and rating label.

\*For information about prices and delivery times, please contact us. Phone: +49 (0) 7182 - 80 404 - 0 · kontakt@sprintus.eu



**CONSUMER PRODUCTS**  
THOUGHT OUT TO THE LAST DETAIL



**MOP STANDS BY ITSELF!**  
No falling over.  
No bending down.



Isoscele bracket for easy mop pad attachment in upright position without bending down.



Large footswitch for convenient opening.

**MOP STANDS BY ITSELF!**  
No falling over, no bending down.

**Click To Mop**  
3 piece complete floor cleaning set

- Incl. mop holder with upright function
- Microfibre mop pad
- Extendable telescopic pole

Item no. 301.088

**Accessories for Click To Mop**

Spare cover (2 pcs.)  
white/blue 42 cm.  
Item no. 301.105

Magnetic duster  
blue, 40 x 20 cm.  
Item no. 302.026





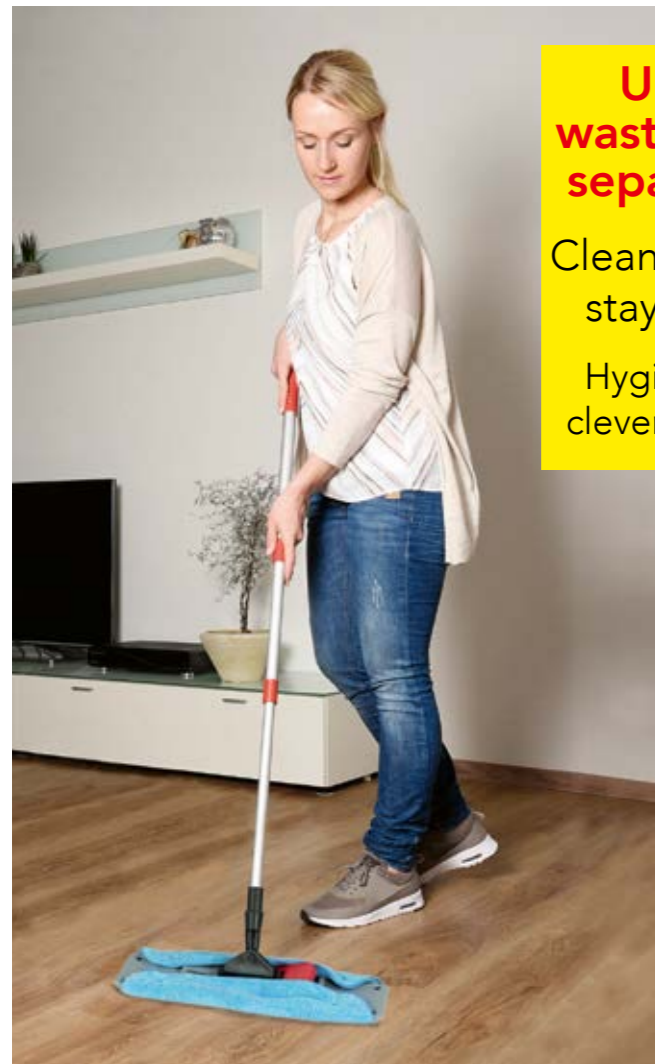

**Unique waste water separation!**  
Cleaning water stays clean.  
Hygienic and clever solution!



### Overview of features

- Mop stands by itself! No falling over, no bending down!
- Unique waste water separation system
- Waste water container can be emptied out separately
- **3in1** Mop holder for dusters, pocket and bracket mops upto 42 cm working width
- Comfortable and easy on your back usage without having to pick up mop pad with hands
- High Quality, from 0,6 to 1,3 m extendable aluminium telescopic pole
- Large foot switch for conveniently closing the mop holder for the hygienic press.



Waste water separation

Perfect separation of cleaning and fresh water



Compact and easy to manoeuvre. Rotating joint for difficult to reach places.

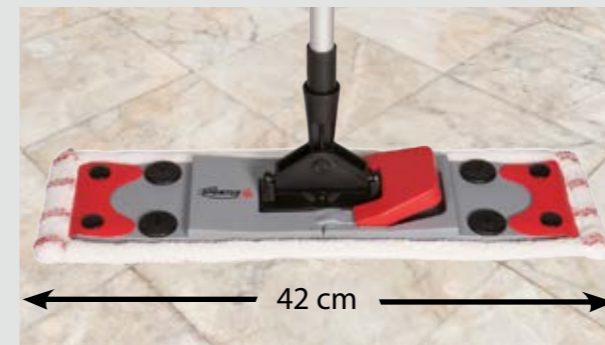

Universal width of 42 cm. Can also be used with commercial pocket mops.



Space-saving storage.

### Accessories for Click 'N' Twist and Click 'N' Press

Spare cover  
Spare white mop pad with press studs.  
Item no. 302.021



Magnetic duster  
blue, 40 x 20 cm.  
Item no. 302.026

### Unique waste water separation!

Cleaning water stays clean longer  
Hygienic and clever solution!

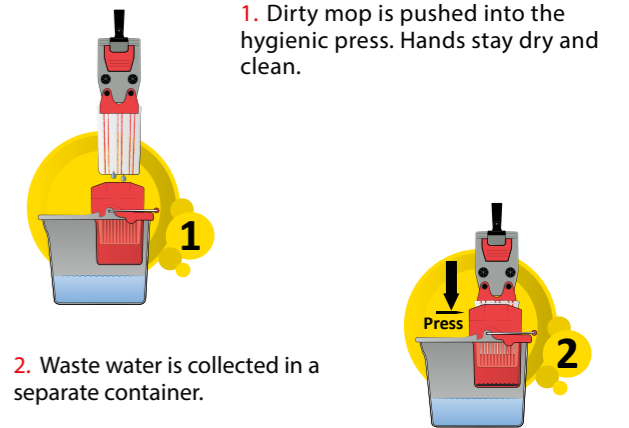

2. Waste water is collected in a separate container.

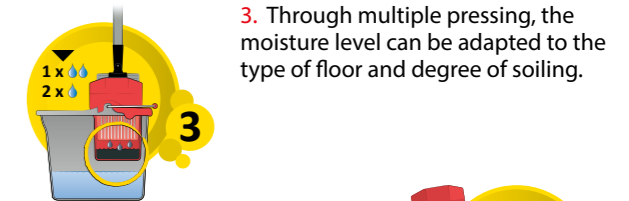

3. Through multiple pressing, the moisture level can be adapted to the type of floor and degree of soiling.

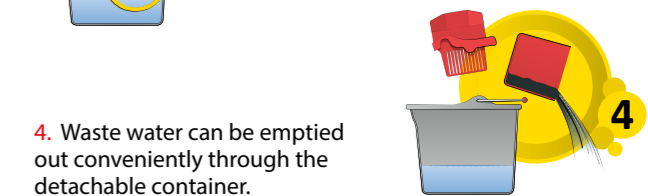

4. Waste water can be emptied out conveniently through the detachable container.



### Click 'N' Press 7-part complete floor cleaning set incl. magnetic duster

- Incl. hygienic **3in1** flat mop holder with upright function
- Microfibre mop pad
- 3-part extendable aluminium telescopic pole
- 12 litre cleaning bucket
- Press insert
- Cleaning water collecting container
- Magnetic duster

Item no. 302.043





PERFECT CLEANING

with high level of drying.

Ideal for sensitive floors.

**i** Overview of features

MEET OUR NEW SPIN MOP System

- Rotation principle with deep splash protection and large foot switch
- Effortless wringing out of mop pad
- High level of drying. Ideal for sensitive floors
- Comfortable, back-friendly working
- Mop pad does not have to be picked up with hands



**3in1**

Can be used with duster, pocket mop and bracket mop.



Large footswitch for convenient opening – Mop pad does not have to be picked up with hands.



Magnetic dust cloth can be attached conveniently.

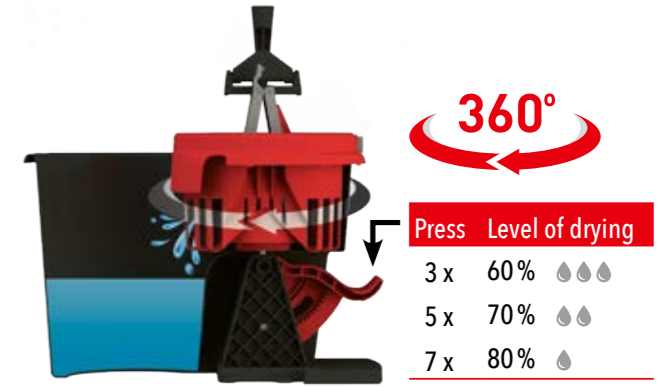

Rotation principle with deep splash protection, high level of drying and large foot switch.



Large footswitch.



Spin function.



The magnetic duster is perfectly suited to wipe dry floors without bringing up dust. Electrostatic charge in the duster holds dust, dirt and pet hair efficiently. The dirty is released only when duster is rinsed out.



Accessories for Click 'N' Twist and Click 'N' Press

Spare cover. Spare white mop pad with press studs. Item no. 302.021



Magnetic duster blue, 40 x 20 cm. Item no. 302.026

Click 'N' Twist 5-part spin mop system incl. magnetic duster with extra high level of drying even for sensitive floors

- Incl. hygienic **3in1** flat mop holder with upright function
- Microfibre mop pad
- 3-part extendable aluminium telescopic pole
- Cleaning bucket with spin system
- Magnetic duster

Item no. 302.061