

ERA EVO

The price-performance winner.



MADE IN GERMANY

DRY VACUUM CLEANERS

The quiet ERA EVO is versatile, compact, reliable and a true powerhouse. The integrated cable rewind makes the safe and practical storage of the signal-red 10m power cord possible. If required, you can change the cable in just a few simple steps and without using any tools.



High-quality filter media, such as the standard fleece filter basket, the HEPA13 filter bag, and the HEPA13 filter cartridge guarantee clean blow-out air at all times and are particularly suitable for those who suffer from allergies or for the cleaning of sensitive areas, such as hospitals, nursing homes and kindergartens. The extra-large, tear-resistant 9-litre fleece filter bag guarantees a high volume of dirt absorption and long working intervals, without frequent and annoying filter bag changes. The power regulation that can be adjusted on the device allows for the EVO to be adapted to any floor covering. And what's best: already for small order quantities, we equip the ERA EVO with your logo and strengthen your company image and brand.

Features

Standard operating LED in blue.



Your brand. Your company image. We imprint your logo.

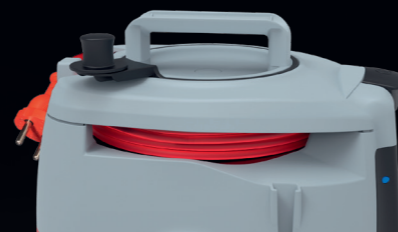

Integrated cable rewind with open design.

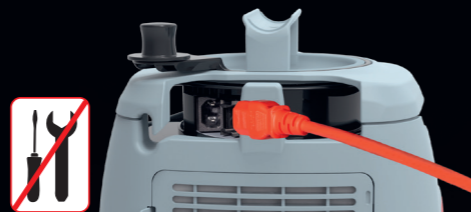

Tool-free cable changing.

Mechanical power regulation.

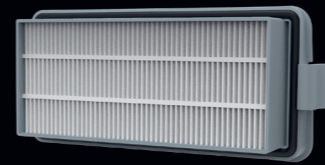

Tool-free removable HEPA13 filter cartridge.

Tip: HEPA 14 filter cartridge, optional for all ERA models.



All-round elastic impact edges and a continuous sliding cam ensures a smooth transition over door thresholds.

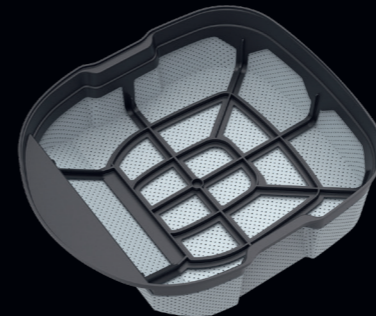

Tool-free interchangeable motor predection filter.

HEPA13 Washable fleece filter basket.

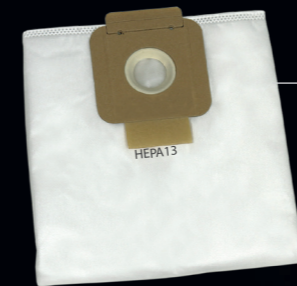

HEPA13 fleece filter bag.

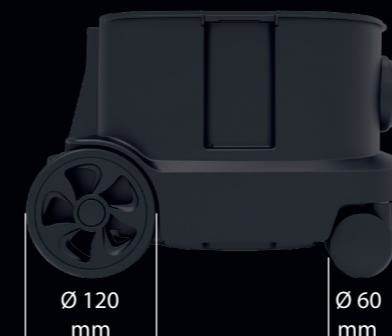

Extra-large wheels and castors ensure a high level of agility and stability.

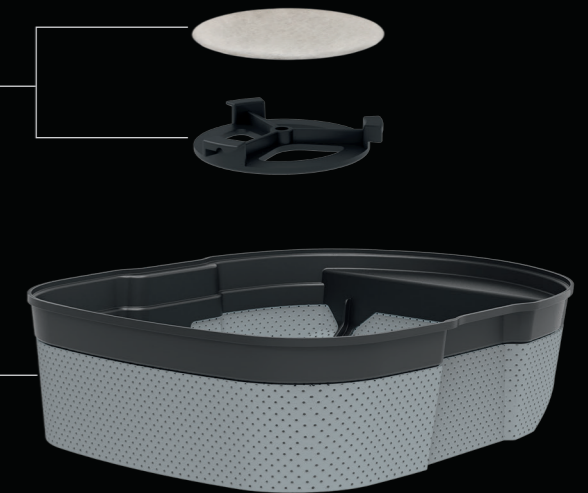

Four storage slots for accessories and three parking positions as standard.



50% RECYCLED MATERIAL

Item-no. UK EU

ERA EVO 117004 117001
NEW ERA EVO ZERO 2117001

2 x 0,5m aluminium tube, 2.0m suction hose, HEPA13 fleece filter basket, HEPA13 fleece filter bag, HEPA13 filter cartridge, crevice nozzle, combined upholstery / furniture nozzle, 280mm combi nozzle, 10m power cord, pluggable, signal red

FLEECE FILTER BAGS:

Fleece filter bags (10 pieces) 106013
 Fleece filter bags (250 pieces) 106014
 HEPA13 fleece filter bag (10 pieces) 106061

STANDARD ACCESSORIES:

Aluminium tube, 0,5 m (1 piece) 106026
 Suction hose complete, 2.5m 114113
 Energy combi nozzle, 280mm 114114
 2in1 upholstery nozzle 106028
 Crevice nozzle, 230mm 101023
 HEPA13 Fleece filter basket 117101
 HEPA13 filter cartridge 111132
 HEPA14 filter cartridge 111193
 Power cord, 10m, pluggable, signal red 111177 111310